

FnIO G - Series:

GN-9287

GN-9287 (Profinet Network Adapter)

Table of Contents

Table of Contents.....	2
History.....	4
1.ENVIRONMENT SPECIFICATION.....	5
2.GN-9287 (PROFINET NETWORK ADAPTER).....	6
2.1 GN-9287 Specification.....	6
2.2 GN-9287 Wiring Diagram.....	8
2.3 GN-9287 LED Indicator.....	9
2.3.1 LED Indicator.....	9
2.3.2 MOD (Module Status LED).....	9
2.3.3 NET (Network Status LED).....	9
2.3.4 ERROR (Error Status LED).....	9
2.3.5 IOS LED (Extension Module Status LED).....	10
2.3.6 Field Power, System Power LED (Field Power, System Power Status LED).....	10
2.4 GN-9287 Electrical Interface.....	11
2.4.1 RJ-45 Socket.....	11
2.4.2 Dip Switch (TBD).....	11
2.4.3 RS232 Port for MODBUS/RTU, Touch Pannel.....	12
3.I/O Process Image Map.....	13
3.1 Mapping Data into Image Table.....	13
3.1.1 Discrete Input Module.....	13
3.1.2 Discrete Output Module.....	14
3.1.3 Analog Input Module.....	15
3.1.4 Analog Output Module.....	16
3.2 Example of Input Process Image (Input Register) Map.....	17
3.3 Example of Output Process Image (Output Register) Map.....	18
3.4 MODBUS Special Register Map.....	19
3.4.1 Adapter Identification Special Register (0x1000, 4096).....	19
3.4.2 Other Time Special Register (0x1028, 4136).....	19
3.4.3 Adapter IP/MAC Address Special Register (0x1050, 4176).....	19
3.4.4 Adapter Information Special Register (0x1100, 4352).....	20
3.4.5 Expasion Slot Information Special Resister (0x2000, 8192).....	21
3.5 MODBUS Reference.....	22
4.PARAMETER.....	23
4.1 GN-9287 Parameter.....	23
4.2 GN-9287 PROFINET IO Characteristics.....	23
4.2.1 Device Identity.....	23

4.2.2 Device Access Point.....	23
4.2.3 Sub-slot of GN-9287.....	23

History

REV.	PAGES	REMARKS	DATE	Editor
Preliminary		Preliminary	August 30, 2018	Joonho, Park
-		Update	January 15, 2019	Joonho, Park
-		NET LED / ERROR LED Indicator Update	February 14, 2019	Joonho, Park
-		GN-9287 Parameter Update	February 20, 2019	Joonho, Park
-		Adapter Identification Special Register Update	April 03, 2019	Joonho, Park
-		Adapter Information Special Register Update	April 09, 2019	Joonho, Park
1.01		IAP Mode Setting Update	October 10, 2019	Joonho, Park
1.02		NA Parameter Data Update	March 03, 2020	Joonho, Park
1.03		Revision related to UL certification	March 10, 2020	GWLEE
1.03	20	Modbus special register map Update(0x1119)	July 07, 2020	Joonho, Park
1.04	11	DIP Switch Function Update	March 26, 2021	Joonho, Park
1.05	10	Changed system/field power LED indicate	June 01, 2023	Joonho, Park

1. ENVIRONMENT SPECIFICATION

Environmental specification	
Operating Temperature	-40°C ~ 60°C : 1.5A full load is allowed.
UL Temperature	-20°C ~ 60°C
Storage Temperature	-40°C ~ 85°C
Relative Humidity	5% ~ 90% non-condensing
Mounting	DIN rail
General specification	
Shock Operating	IEC 60068-2-27
Vibration Resistance	Based on IEC 60068-2-6 DNVGL-CG-0039 : Vibration Class B, 4g
Industrial Emissions	EN 61000-6-4/A11 : 2011
Industrial Immunity	EN 61000-6-2 : 2005
Installation Position	Vertical and horizontal installation is available.
Product Certifications	CE, UL, FCC

2. GN-9287 (PROFINET NETWORK ADAPTER)

2.1 GN-9287 Specification

Items	Specification
Communication Specification	
Adapter Type	Slave node (Profinet)
Protocol	Profinet, Modbus RTU
Max. Expansion Module	32 slots
Max. Data Size	Max 1440 bytes
Max Length Bus Line	Up to 100m from Ethernet Hub/Switch with twisted CAT5 UTP/STP
Max. Nodes	Limited by Profinet Specification.
Baud Rate	100Mbps, Auto-negotiation, Full duplex
Interface Connector	RJ-45 socket * 2pcs
IP-Address Setup	Via Master Device Software
Max. Parameter Size	2048 Bytes (ex : 1 slot = 64 Byte + I/O Parameter Size(Dword size))
IAP Mode	When DIP Switch 1 to 8 setting is 254 or 255 (Using only Internet Explorer / recommended version 11)
Serial Port	RS232 for MODBUS/RTU, Touch Pannel
Serial Configuration (RS232)	Node : 1 (Fixed) Baud Rate : 115200 (Fixed) Data bit : 8 (Fixed) Parity bit : No parity (Fixed) Stop bit : 1 (Fixed)
Indicator	6 LED 1 Green/Red, Module Status (MOD) 1 Green, Physical Connection (NET) 1 Green/Red, Network Error (ERROR) 1 Green/Red, Expansion I/O Module Status (IOS) 1 Green, System Power Status 1 Green, Field Power Status 2 LED (each RJ45 Connector) 1 Yellow, Link/Active 1 Green, Not used
Module Location	Starter module left side of G-Series system
Field Power Detection	About 14Vdc
General specification	
UL System Power	Supply voltage : 24Vdc nominal, Class 2
System Power	Supply voltage : 24Vdc nominal Supply voltage range : 15~30Vdc Protection : Output current limit (Min. 1.5A) Reverse polarity protection
Power Dissipation	70mA typical @ 24Vdc
Current for I/O Module	1.5A @ 5Vdc
Isolation	System power to internal logic : Non-isolation System power I/O driver : Isolation
UL Field Power	Supply voltage : 24Vdc nominal, Class 2
Field Power	Supply voltage : 24Vdc typical (Max. 30Vdc) * Field Power Range is different depending on IO Module series. Refer to IO Module's Specification.
Max. Current Field Power Contact	DC 10A Max
Wiring	I/O Cable Max. 2.0mm ² (AWG 14)
Torque	0.8Nm(7 lb-in)
Weight	172g
Module Size	54mm x 99mm x 70mm

Environment Condition	Refer to '1. Environment Specification'
------------------------------	--

2.2 GN-9287 Wiring Diagram

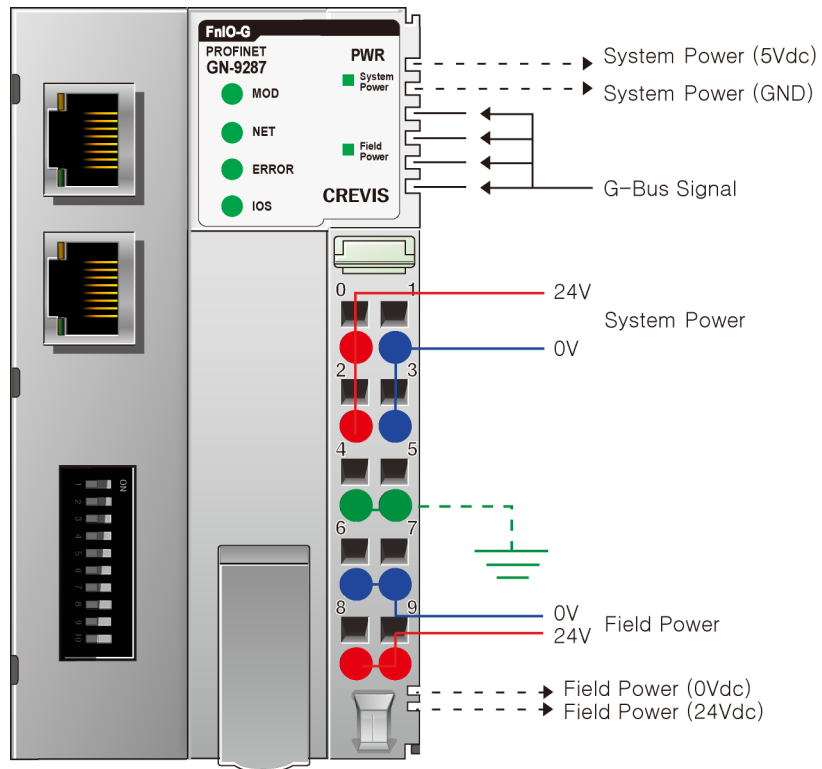

Pin No.	Signal Description	Signal Description	Pin No.
0	System Power, 24V	System Power, Ground	1
2	System Power, 24V	System Power, Ground	3
4	F.G	F.G	5
6	Field Power, Ground	Field Power, Ground	7
8	Field Power, 24V	Field Power, 24V	9

2.3 GN-9287 LED Indicator

2.3.1 LED Indicator

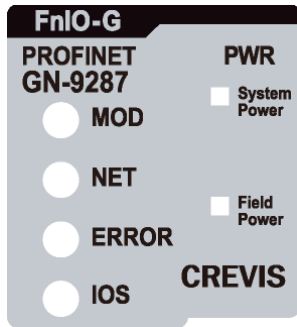

LED No.	LED Function / Description	LED Color
MOD	Module status	Green/Red
NET	Current communication status	Green
ERROR	Error Status (Profinet)	Green
IOS	Extension Module Status	Green/Red
System Power	System Power Enable	Green
Field Power	Field Power Enable	Green

2.3.2 MOD (Module Status LED)

Status	LED	To indicate
No Powered	OFF	No power is supplied to the unit.
Device Operational	Green	The unit is operating in normal condition.
Unrecoverable Fault	Red	The device has an unrecoverable fault. - Memory error or CPU watchdog error.

2.3.3 NET (Network Status LED)

Status	LED	To indicate
No Powered	OFF	No power is supplied to the unit.
Communication	Green	Normal communication.
Communication Ready	Flashing Green	Communication identification.
Invalid Configuration	Flashing Red	DCP Communication error(Invalid Configuration).

2.3.4 ERROR (Error Status LED)

Status	LED	To indicate
No Error	OFF	No Error.
Connection error	Red	Communication connection error.

2.3.5 IOS LED (Extension Module Status LED)

Status	LED	To indicate
Not Powered	OFF	Device may not be powered.
No Expansion Module	Flashing Red	Adapter has no expansion module
Internal Bus Connection, Run Exchanging I/O	Green	Exchanging I/O data.
Expansion Configuration Failed	Red	One or more expansion module occurred in fault state. <ul style="list-style-type: none"> - Detected invalid expansion module ID. - Overflowed Input/Output Size - Too many expansion module - Initialization failure - Communication failure. - Changed expansion module configuration. - Mismatch vendor code between adapter and expansion module.

2.3.6 Field Power, System Power LED (Field Power, System Power Status LED)

Status	LED	To indicate
No field, System power	OFF	Not supplied 24Vdc system power, 5Vdc system power.
Supplied field, System power	Green	Supplied 24Vdc field power, 5Vdc system power.

2.4 GN-9287 Electrical Interface

2.4.1 RJ-45 Socket

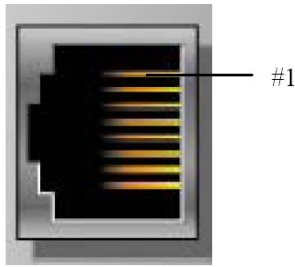

Shielded RJ-45 Socket

RJ-45	Signal Name	Description
1	TD+	Transmit +
2	TD-	Transmit -
3	RD+	Receive +
4	-	
5	-	
6	RD-	Receive -
7	-	
8	-	
Case	Shield	

2.4.2 Dip Switch

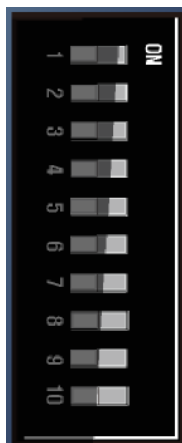

DIP Pole#	Description	
1	Node ID Bit0	Device Name (GN9287-XX) - XX must a value between 1~99.
2	Node ID Bit1	
3	Node ID Bit2	
4	Node ID Bit3	
5	Node ID Bit4	
6	Node ID Bit5	
7	Node ID Bit6	
8	Reserve	
9	IP Address (By Master)	
10	Node ID : Flash Memory Value	

• **When the dip switch is not set to non-zero (1~99):**

If the decimal value of the dip switch is not zero (0), the name of device will be fixed as “GN9287-xx” (xx: 1~99). You must put the fixed device name.

• **When the dip switch “9 pole” is set to switch ON:**

When the GN-9287 device is powered on, the IP Address, Gateway, and Subnet mask values stored in the EEPROM are set as default values.(Regardless of the dip switch value).

If the IP address, Gateway and Subnet mask values assigned from the master device are different from the stored EEPROM values, The value that assigned from the master are written to the EEPROM.

• **When the dip switch “10 pole” is set to switch ON:**

GN-9287 Devices on a PROFINET subnet must have unique names. The device names must satisfy DNS naming conventions. This means that the following rules must be observed:

- Names are limited to a total of 127 characters (letters, numbers, dashes or dots)
- Any component part (that is, a character string between two dots) of the device name may only be up to 63 characters long.
- Names cannot contain any special characters such as umlauts, parentheses, underscores, forward or backward slashes, empty spaces, etc. The dash is the only special character allowed.
- Names must not begin or end with the "-" or "." characters.
- Names must not have the format n.n.n.n (where n = 0..999).
- The device name must not start with numbers.

Device names are assigned to PROFINET IO device when the device is being set up and placed in operation for the first time ("commissioned").

The default name is “GN9287-address”.

2.4.3 RS232 Port for MODBUS/RTU, Touch Pannel

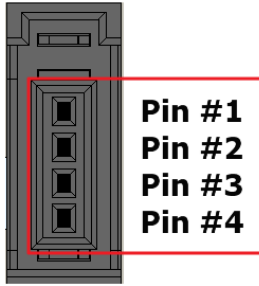

RS232 (37204-62A3-004PL/3M)		
Pin#	Signal Name	Description
1	Reserved	----
2	TXD	RS232 TXD
3	RXD	RS232 RXD
4	GND	RS232 GND

3. I/O Process Image Map

An expansion module may have 3 types of data as I/O data, configuration parameter and memory register. The data exchange between network adapter and expansion modules is done via an I/O process image data by G-Series protocol. The following figure shows the data flow of process image between network adapter and expansion modules.

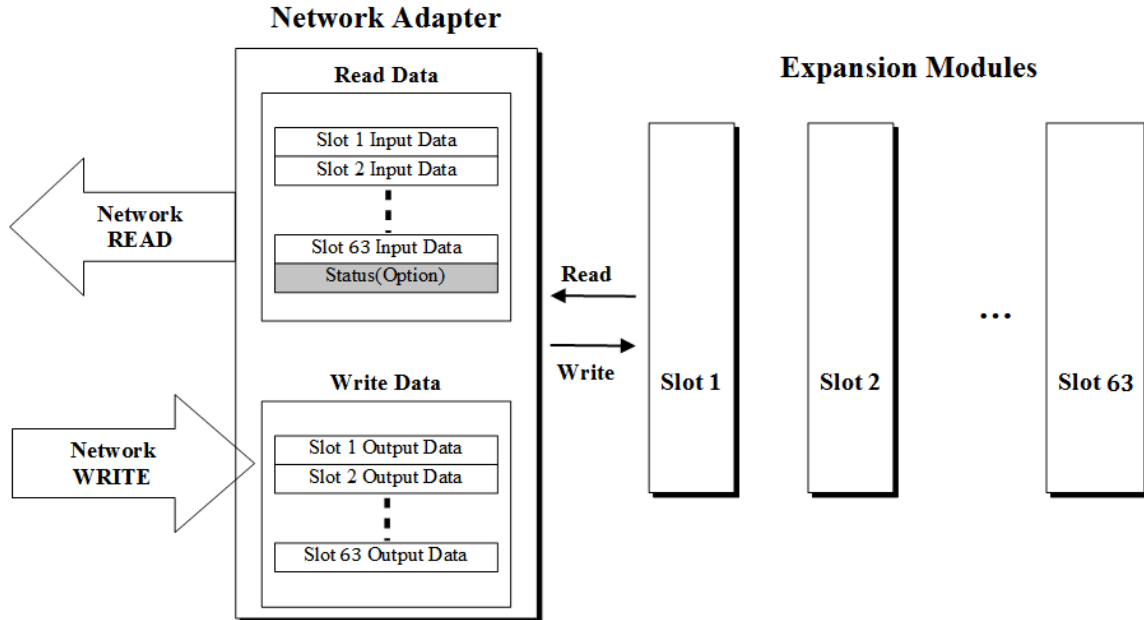

3.1 Mapping Data into Image Table

3.1.1 Discrete Input Module

- 4 Point Input Module

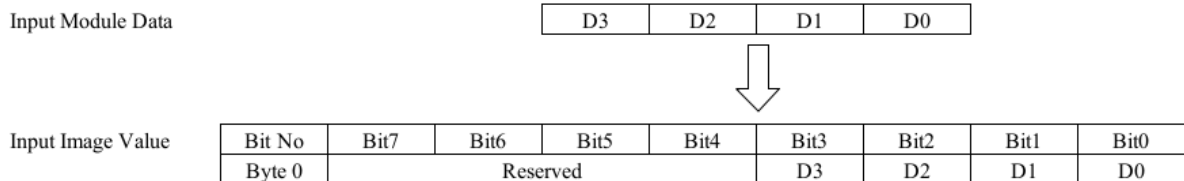

- 8 Point Input Module

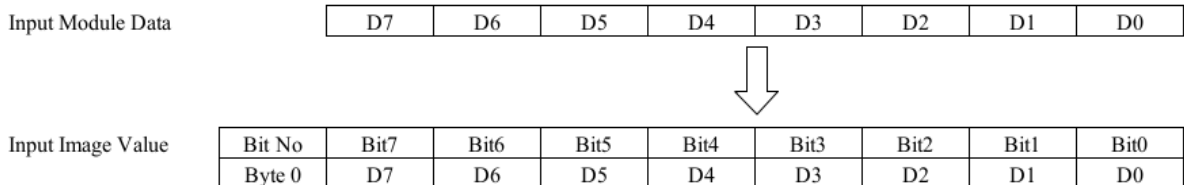

- 16 Point Input Module

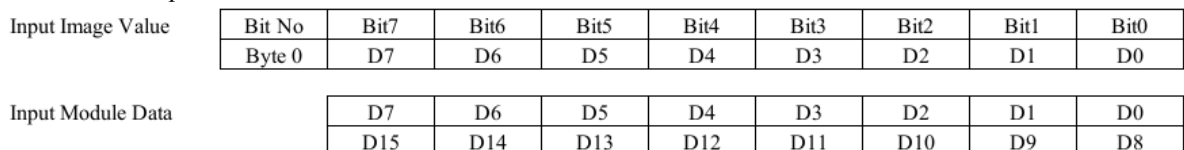

- 32 Point Input Module

Input Module Data

D7	D6	D5	D4	D3	D2	D1	D0
D15	D14	D13	D12	D11	D10	D9	D8
D23	D22	D21	D20	D19	D18	D17	D16
D31	D30	D29	D28	D27	D26	D25	D24



Input Image Value

Bit No	Bit7	Bit6	Bit5	Bit4	Bit3	Bit2	Bit1	Bit0
Byte 0	D7	D6	D5	D4	D3	D2	D1	D0
Byte 1	D15	D14	D13	D12	D11	D10	D9	D8
Byte 2	D23	D22	D21	D20	D19	D18	D17	D16
Byte 3	D31	D30	D29	D28	D27	D26	D25	D24

3.1.2 Discrete Output Module

- 4 Point Output Module

Output Image Value

Bit No	Bit7	Bit6	Bit5	Bit4	Bit3	Bit2	Bit1	Bit0
Byte 0	Reserved				D3	D2	D1	D0



Output Module Data

D3	D2	D1	D0
----	----	----	----

- 8 Point Output Module

Output Image Value

Bit No	Bit7	Bit6	Bit5	Bit4	Bit3	Bit2	Bit1	Bit0
Byte 0	D7	D6	D5	D4	D3	D2	D1	D0



Output Module Data

D7	D6	D5	D4	D3	D2	D1	D0
----	----	----	----	----	----	----	----

- 16 Point Output Module

Output Image Value

Bit No	Bit7	Bit6	Bit5	Bit4	Bit3	Bit2	Bit1	Bit0
Byte 0	D7	D6	D5	D4	D3	D2	D1	D0
Byte 1	D15	D14	D13	D12	D11	D10	D9	D8



Output Module Data

D7	D6	D5	D4	D3	D2	D1	D0
D15	D14	D13	D12	D11	D10	D9	D8

- 32 Point Output Module

Output Image Value

Bit No	Bit7	Bit6	Bit5	Bit4	Bit3	Bit2	Bit1	Bit0
Byte 0	D7	D6	D5	D4	D3	D2	D1	D0
Byte 1	D15	D14	D13	D12	D11	D10	D9	D8
Byte 2	D23	D22	D21	D20	D19	D18	D17	D16
Byte 3	D31	D30	D29	D28	D27	D26	D25	D24



Output Module Data

D7	D6	D5	D4	D3	D2	D1	D0
D15	D14	D13	D12	D11	D10	D9	D8
D23	D22	D21	D20	D19	D18	D17	D16
D31	D30	D29	D28	D27	D26	D25	D24

3.1.3 Analog Input Module

- 4 Channel Analog Input Module

Input Module Data	Analog Input Ch0
	Analog Input Ch1
	Analog Input Ch2
	Analog Input Ch3



Input Image Value	Bit No	Bit7	Bit6	Bit5	Bit4	Bit3	Bit2	Bit1	Bit0
	Byte 0	Analog Input Ch0 low byte							
	Byte 1	Analog Input Ch0 high byte							
	Byte 2	Analog Input Ch1 low byte							
	Byte 3	Analog Input Ch1 high byte							
	Byte 4	Analog Input Ch2 low byte							
	Byte 5	Analog Input Ch2 high byte							
	Byte 6	Analog Input Ch3 low byte							
	Byte 7	Analog Input Ch3 high byte							

- 8 Channel Analog Input Module

Input Module Data	Analog Input Ch0
	Analog Input Ch1
	Analog Input Ch2
	Analog Input Ch3
	Analog Input Ch4
	Analog Input Ch5
	Analog Input Ch6
	Analog Input Ch7



Input Image Value	Bit No	Bit7	Bit6	Bit5	Bit4	Bit3	Bit2	Bit1	Bit0
	Byte 0	Analog Input Ch0 low byte							
	Byte 1	Analog Input Ch0 high byte							
	Byte 2	Analog Input Ch1 low byte							
	Byte 3	Analog Input Ch1 high byte							
	Byte 4	Analog Input Ch2 low byte							
	Byte 5	Analog Input Ch2 high byte							
	Byte 6	Analog Input Ch3 low byte							
	Byte 7	Analog Input Ch3 high byte							
	Byte 8	Analog Input Ch4 low byte							
	Byte 9	Analog Input Ch4 high byte							
	Byte 10	Analog Input Ch5 low byte							
	Byte 11	Analog Input Ch5 high byte							
	Byte 12	Analog Input Ch6 low byte							
	Byte 13	Analog Input Ch6 high byte							
	Byte 14	Analog Input Ch7 low byte							
	Byte 15	Analog Input Ch7 high byte							

3.1.4 Analog Output Module

- 4 Channel Analog Input Module

Output Image Value	Bit No	Bit7	Bit6	Bit5	Bit4	Bit3	Bit2	Bit1	Bit0
Byte 0	Analog Output Ch0 low byte								
Byte 1	Analog Output Ch0 high byte								
Byte 2	Analog Output Ch1 low byte								
Byte 3	Analog Output Ch1 high byte								
Byte 4	Analog Output Ch2 low byte								
Byte 5	Analog Output Ch2 high byte								
Byte 6	Analog Output Ch3 low byte								
Byte 7	Analog Output Ch3 high byte								



Output Module Data	Analog Output Ch0
	Analog Output Ch1
	Analog Output Ch2
	Analog Output Ch3

- 8 Channel Analog Input Module

Output Image Value	Bit No	Bit7	Bit6	Bit5	Bit4	Bit3	Bit2	Bit1	Bit0
Byte 0	Analog Output Ch0 low byte								
Byte 1	Analog Output Ch0 high byte								
Byte 2	Analog Output Ch1 low byte								
Byte 3	Analog Output Ch1 high byte								
Byte 4	Analog Output Ch2 low byte								
Byte 5	Analog Output Ch2 high byte								
Byte 6	Analog Output Ch3 low byte								
Byte 7	Analog Output Ch3 high byte								
Byte 8	Analog Output Ch4 low byte								
Byte 9	Analog Output Ch4 high byte								
Byte 10	Analog Output Ch5 low byte								
Byte 11	Analog Output Ch5 high byte								
Byte 12	Analog Output Ch6 low byte								
Byte 13	Analog Output Ch6 high byte								
Byte 14	Analog Output Ch7 low byte								
Byte 15	Analog Output Ch7 high byte								



Output Module Data	Analog Output Ch0
	Analog Output Ch1
	Analog Output Ch2
	Analog Output Ch3
	Analog Output Ch4
	Analog Output Ch5
	Analog Output Ch6
	Analog Output Ch7

3.2 Example of Input Process Image (Input Register) Map

Input image data depends on slot position and expansion slot data type. Input process image data is only ordered by expansion slot position .

- For example slot configuration

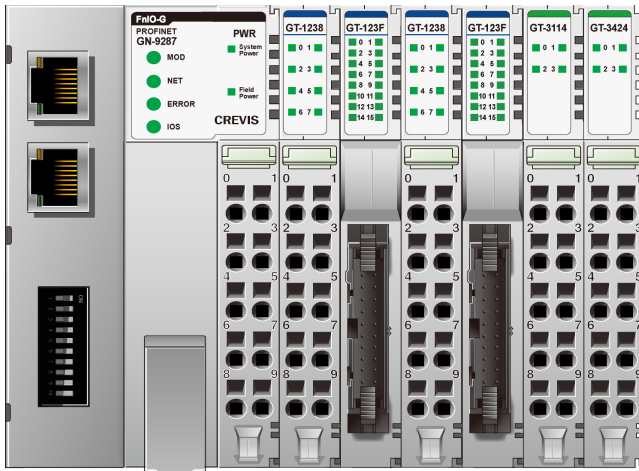

Slot Address	Module Description
#0	ProfiNet Adapter
#1	8-discrete input
#2	16-discrete input
#3	8-discrete input
#4	16-discrete input
#5	4-analog input
#6	4-analog input

- Input Process Image

Byte	Slot #	Bit 7	Bit 6	Bit 5	Bit 4	Bit 3	Bit 2	Bit 1	Bit 0	
Read Byte 0	Slot 1	Discrete Input 8 Point								
Read Byte 1	Slot 2	Discrete Input 16 Point low byte								
Read Byte 2		Discrete Input 16 Point high byte								
Read Byte 3	Slot 3	Discrete Input 8 Point								
Read Byte 4	Slot 4	Discrete Input 16 Point low byte								
Read Byte 5		Discrete Input 16 Point high byte								
Read Byte 6	Slot 5	Analog Input Ch0 low byte								
Read Byte 7		Analog Input Ch0 high byte								
Read Byte 8		Analog Input Ch1 low byte								
Read Byte 9		Analog Input Ch1 high byte								
Read Byte 10		Analog Input Ch2 low byte								
Read Byte 11		Analog Input Ch2 high byte								
Read Byte 12		Analog Input Ch3 low byte								
Read Byte 13		Analog Input Ch3 high byte								
Read Byte 14		Slot 6	Analog Input Ch0 low byte							
Read Byte 15			Analog Input Ch0 high byte							
Read Byte 16			Analog Input Ch1 low byte							
Read Byte 17			Analog Input Ch1 high byte							
Read Byte 18	Analog Input Ch2 low byte									
Read Byte 19	Analog Input Ch2 high byte									
Read Byte 20	Analog Input Ch3 low byte									
Read Byte 21	Analog Input Ch3 high byte									

3.3 Example of Output Process Image (Output Register) Map

Output image data depends on slot position and expansion slot data type. Output process image data is only ordered by expansion slot position.

- For example slot configuration

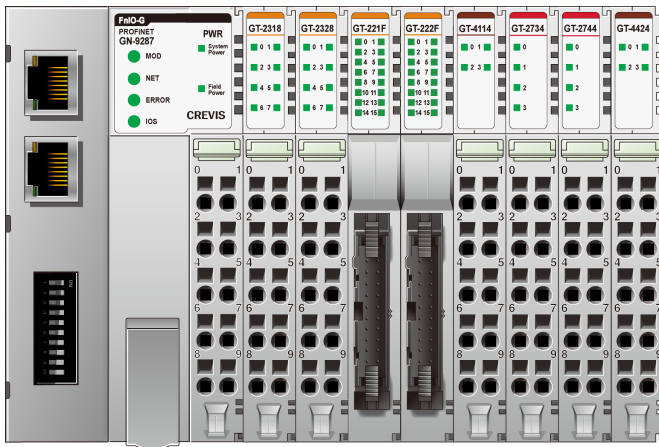

Slot Address	Module Description
#0	ProfiNet Adapter
#1	8-discrete output
#2	8-discrete output
#3	16-discrete output
#4	16-discrete output
#5	4-analog output
#6	4-relay output
#7	4-relay output
#8	4-analog output

- Output Process Image

Byte	Slot #	Bit 7	Bit 6	Bit 5	Bit 4	Bit 3	Bit 2	Bit 1	Bit 0	Bit 0
Write Byte 0	Slot 1	Discrete Output 8 Point								
Write Byte 1	Slot 2	Discrete Output 8 Point								
Write Byte 2	Slot 3	Discrete Output 16 Point low byte								
Write Byte 3		Discrete Output 16 Point high byte								
Write Byte 4	Slot 4	Discrete Output 16 Point low byte								
Write Byte 5		Discrete Output 16 Point high byte								
Write Byte 6		Analog Output Ch0 low byte								
Write Byte 7	Slot 5	Analog Output Ch0 high byte								
Write Byte 8		Analog Output Ch1 low byte								
Write Byte 9		Analog Output Ch1 high byte								
Write Byte 10		Analog Output Ch2 low byte								
Write Byte 11		Analog Output Ch2 high byte								
Write Byte 12		Analog Output Ch3 low byte								
Write Byte 13		Analog Output Ch3 high byte								
Write Byte 14	Slot 6	Not used				Discrete Output 4 Point				
Write Byte 15	Slot 7	Not used				Discrete Output 4 Point				
Write Byte 16	Slot 8	Analog Output Ch0 low byte								
Write Byte 17		Analog Output Ch0 high byte								
Write Byte 18		Analog Output Ch1 low byte								
Write Byte 19		Analog Output Ch1 high byte								
Write Byte 20		Analog Output Ch2 low byte								
Write Byte 21		Analog Output Ch2 high byte								
Write Byte 22		Analog Output Ch3 low byte								
Write Byte 23	Analog Output Ch3 high byte									

3.4 MODBUS Special Register Map

The special register map can be accessed by function code 3, 4, 6 and 16. Also the special register map must be accessed by read/write of every each address (one address).

3.4.1 Adapter Identification Special Register (0x1000, 4096)

Address	Access	Type, Size	Description
0x1000(4096)	Read	1 word	Vendor ID = 0x0140(320), Crevis. Co., Ltd.
0x1001(4097)	Read	1 word	Device type = 0x000C, Network Adapter
0x1002(4098)	Read	1 word	Product Code = 0x9070
0x1003(4099)	Read	1 word	Firmware revision, if 0x0101, revision 1.01
0x1004(4100)	Read	2 words	Product unique serial number
0x1005(4101)	Read	String upto 34bytes	Product name string (ASCII) “GN-9287,PROFINET,GBUS”
0x1006(4102)	Read	1 word	Sum check of EEPROM
0x1010(4112)	Read	2 words	Firmware release date
0x1011(4113)	Read	2 words	Product manufacturing inspection date
0x101E(4126)	Read	7 words - 1 word - 1 word - 1 word - 1 word - 1 word - 2 words	Composite Id of following address * RTU mode 0x1100(4352), Modbus RS232 Node. (Fixed 0x0001) 0x1000(4096), Vendor ID 0x1001(4097), Device type 0x1002(4098), Product code 0x1003(4099), Firmware revision 0x1004(4100), Product serial number

- String Type consists of valid string length (first 1 word) and array of characters

3.4.2 Other Time Special Register (0x1028, 4136)

Address	Access	Type, Size	Description
0x1028(4136)	Read	1 word	IO update time, main loop time. (1usec unit)

3.4.3 Adapter IP/MAC Address Special Register (0x1050, 4176)

Address	Access	Type, Size	Description
0x1050(4176)	Read/Write	2 words	IP address. If 192.168.123.1, then 0xA8C0, 0x017B. After update this value, IP address, Subnet mask and Gateway are applied as new one.
0x1051(4177)	Read/Write	2 words	Subnet mask. If 255.255.255.0, then 0xFFFF, 0x00FF.
0x1052(4178)	Read/Write	2 words	Gateway. If 192.168.123.254, then 0xA8C0, 0xFE7B.
0x1053(4179)	Read	3 words	Ethernet physical address (MAC-ID). If 11-22-33-44-55-66, then 0x2211, 0x4433, 0x6655.

3.4.4 Adapter Information Special Register (0x1100, 4352)

Address	Access	Type, Size	Description																								
0x1100(4352)*	Read	1 word	Current STATION-NUMBER. If Dip SW 10 = Off																								
0x1102(4354)	Read	1 word	Start address of input image word register. =0x0000																								
0x1103(4355)	Read	1 word	Start address of output image word register. =0x0800																								
0x1104(4356)	Read	1 word	Size of input image word register.																								
0x1105(4357)	Read	1 word	Size of output image word register.																								
0x1106(4358)	Read	1 word	Start address of input image bit. = 0x0000																								
0x1107(4359)	Read	1 word	Start address of output image bit. =0x1000																								
0x1108(4360)	Read	1 word	Size of input image bit.																								
0x1109(4361)	Read	1 word	Size of output image bit.																								
0x110A(4362)	Read	1 word	Update time for cyclic data change (same as 0x1028)																								
0x110D(4365)	Read	1 word	Current Dip Switch State and Field Power Status (MSB) ex) Flash memory Value using, Dip SW(0x01), Field Power On = 0x8201																								
0x110E(4366)	Read	upto 33words	Expansion slot's GT-number including GN First 1 word is adapter's number, if GN-9287, then 0x9287																								
0x1110(4368)	Read	1 word	Number of expansion slot																								
0x1113(4371)	Read	upto 33words	Expansion slot Module Id. First 1 word is adapter's module id.																								
0x1119(4377)	Read	1 word	Hi byte is ModBus status, low byte is internal bus status. Zero value means 'no error'. <table border="1" style="width: 100%; border-collapse: collapse;"> <thead> <tr> <th style="width: 50%;">ModBus status</th> <th style="width: 50%;">Internal bus status(G-Bus)</th> </tr> </thead> <tbody> <tr> <td></td> <td>0x00 : OPERATING</td> </tr> <tr> <td></td> <td>0x01 : COMMUNICATION_FAULT</td> </tr> <tr> <td></td> <td>0x02 : CONNECT_FAULT</td> </tr> <tr> <td></td> <td>0x03 : CONFIG_FAULT</td> </tr> <tr> <td></td> <td>0x04 : NO_EXPANSION</td> </tr> <tr> <td></td> <td>0x05 : NVALID_ATTR_VALUE</td> </tr> <tr> <td></td> <td>0x06 : TOO_MUCH_DATA</td> </tr> <tr> <td></td> <td>0x07 : VENDOR_ERROR</td> </tr> <tr> <td></td> <td>0x08 : NOT_EXPECTED_SLOT</td> </tr> <tr> <td></td> <td>0x09 : CRC_ERROR</td> </tr> <tr> <td></td> <td>0x80 : NO FIELD POWER</td> </tr> </tbody> </table>	ModBus status	Internal bus status(G-Bus)		0x00 : OPERATING		0x01 : COMMUNICATION_FAULT		0x02 : CONNECT_FAULT		0x03 : CONFIG_FAULT		0x04 : NO_EXPANSION		0x05 : NVALID_ATTR_VALUE		0x06 : TOO_MUCH_DATA		0x07 : VENDOR_ERROR		0x08 : NOT_EXPECTED_SLOT		0x09 : CRC_ERROR		0x80 : NO FIELD POWER
ModBus status	Internal bus status(G-Bus)																										
	0x00 : OPERATING																										
	0x01 : COMMUNICATION_FAULT																										
	0x02 : CONNECT_FAULT																										
	0x03 : CONFIG_FAULT																										
	0x04 : NO_EXPANSION																										
	0x05 : NVALID_ATTR_VALUE																										
	0x06 : TOO_MUCH_DATA																										
	0x07 : VENDOR_ERROR																										
	0x08 : NOT_EXPECTED_SLOT																										
	0x09 : CRC_ERROR																										
	0x80 : NO FIELD POWER																										
0x111D(4381)	Read	1 word	Adapter G-Series Revision.																								

* After the system is reset, the new "Set Value" action is applied.

** If the slot location is changed, set default value automatically (all expansion slot are live).

3.4.5 Expansion Slot Information Special Resister (0x2000, 8192)

Each expansion slot has 0x20(32) address offset and same information structure.

Slot#1 0x2000(8192)~0x201F(8223)	Slot#2 0x2020(8224)~0x203F(8255)
Slot#3 0x2040(8256)~0x205F(8287)	Slot#4 0x2060(8288)~0x207F(8319)
Slot#5 0x2080(8320)~0x209F(8351)	Slot#6 0x20A0(8352)~0x20BF(8383)
Slot#7 0x20C0(8384)~0x20DF(8415)	Slot#8 0x20E0(8416)~0x20FF(8447)
Slot#9 0x2100(8448)~0x211F(8479)	Slot#10 0x2120(8480)~0x213F(8511)
Slot#11 0x2140(8512)~0x215F(8543)	Slot#12 0x2160(8544)~0x217F(8575)
Slot#13 0x2180(8576)~0x219F(8607)	Slot#14 0x21A0(8608)~0x21BF(8639)
.....	
Slot#32 0x23E0(9184)~0x23FF(9215)	

Address Offset	Expansion Slot#1	Expansion Slot#2	Expansion Slot#3	Expansion Slot#32
+ 0x00(+0)	0x2000(8192)	0x2020(8224)	0x2040(8256)	0x27C0(10176)
+ 0x01(+1)	0x2001(8193)	0x2021(8225)	0x2041(8257)	0x27C1(10177)
+ 0x02(+2)	0x2002(8194)	0x2022(8226)	0x2042(8258)	0x27C2(10178)
+ 0x03(+3)	0x2003(8195)	0x2023(8227)	0x2043(8259)	0x27C3(10179)
+ 0x04(+4)	0x2004(8196)	0x2024(8228)	0x2044(8260)	0x27C4(10180)
+ 0x05(+5)	0x2005(8197)	0x2025(8229)	0x2045(8261)	0x27C5(10181)
+ 0x06(+6)	0x2006(8198)	0x2026(8230)	0x2046(8262)	0x27C6(10182)
+ 0x07(+7)	0x2007(8199)	0x2027(8231)	0x2047(8263)	0x27C7(10183)
+ 0x08(+8)	0x2008(8200)	0x2028(8232)	0x2048(8264)	0x27C8(10184)
+ 0x09(+9)	0x2009(8201)	0x2029(8233)	0x2049(8265)	0x27C9(10185)
+ 0x0A(+10)	0x200A(8202)	0x202A(8234)	0x204A(8266)	0x27CA(10186)
+ 0x0B(+11)	0x200B(8203)	0x202B(8235)	0x204B(8267)	0x27CB(10187)
+ 0x0C(+12)	0x200C(8204)	0x202C(8236)	0x204C(8268)	0x27CC(10188)
+ 0x0D(+13)	0x200D(8205)	0x202D(8237)	0x204D(8269)	0x27CD(10189)
+ 0x0E(+14)	0x200E(8206)	0x202E(8238)	0x204E(8270)	0x27CE(10190)
+ 0x0F(+15)	0x200F(8207)	0x202F(8239)	0x204F(8271)	0x27CF(10191)
+ 0x10(+16)	0x2010(8208)	0x2030(8240)	0x2050(8272)	0x27D0(10192)
+ 0x11(+17)	0x2011(8209)	0x2031(8241)	0x2051(8273)	0x27D1(10193)
+ 0x12(+18)	0x2012(8210)	0x2032(8242)	0x2052(8274)	0x27D2(10194)
+ 0x13(+19)	0x2013(8211)	0x2033(8243)	0x2053(8275)	0x27D3(10195)
+ 0x14(+20)	0x2014(8212)	0x2034(8244)	0x2054(8276)	0x27D4(10196)
+ 0x15(+21)	0x2015(8213)	0x2035(8245)	0x2055(8277)	0x27D5(10197)
+ 0x16(+22)	0x2016(8214)	0x2036(8246)	0x2056(8278)	0x27D6(10198)
+ 0x17(+23)	0x2017(8215)	0x2037(8247)	0x2057(8279)	0x27D7(10199)
+ 0x18(+24)	0x2018(8216)	0x2038(8248)	0x2058(8280)	0x27D8(10200)
+ 0x19(+25)	0x2018(8217)	0x2038(8249)	0x2058(8281)	0x27D9(10201)
+ 0x1A(+26)	0x201A(8218)	0x203A(8250)	0x205A(8282)	0x27DA(10202)
+ 0x1B(+27)	0x201B(8219)	0x203B(8251)	0x205B(8283)	0x27DB(10203)
+ 0x1C(+28)	0x201C(8220)	0x203C(8252)	0x205C(8284)	0x27DC(10204)
+ 0x1D(+29)	0x201D(8221)	0x203D(8253)	0x205D(8285)	0x27DD(10205)
+ 0x1E(+30)	0x201E(8222)	0x203E(8254)	0x205E(8286)	0x27DE(10206)
+ 0x1F(+31)	0x201F(8223)	0x203F(8255)	0x205F(8287)	0x27DF(10207)

Address Offset	Access	Type, Size	Description
+ 0x02(+2) **	Read	1 word	Input start register address of input image word this slot.
+ 0x03(+3) **	Read	1 word	Input word's bit offset of input image word this slot.
+ 0x04(+4) **	Read	1 word	Output start register address of output image word this slot.
+ 0x05(+5) **	Read	1 word	Output word's bit offset of output image word this slot.
+ 0x06(+6) **	Read	1 word	Input bit start address of input image bit this slot.
+ 0x07(+7) **	Read	1 word	Output bit start address of output image bit this slot.
+ 0x08(+8) **	Read	1 word	Size of input bit this slot
+ 0x09(+9) **	Read	1 word	Size of output bit this slot
+ 0x0A(+10)**	Read	n words	Read input data this slot
+ 0x0B(+11)**	Read/Write	n words	Read/write output data this slot
+ 0x0E(+14)	Read	1 word	GT-number, if GT-1238, returns 0x1238
+ 0x0F(+15)	Read	String upto 72bytes	First 1 word is length of valid character string. If GT-1238, returns "00 1E 52 54 2D 31 32 33 38 2C 20 38 44 49 2C 20 32 34 56 64 63 2C 20 55 6E 69 76 65 72 73 61 6C 00 00" Valid character size = 0x001E =30 characters, "GT-1238, 8DI, 24Vdc, Universal"
+ 0x10(+16)	Read	1 word	Size of configuration parameter byte
+ 0x11(+17)**	Read/Write	n words	Read/write Configuration parameter data, Refer to each IO parameter Specification.
+ 0x17(+23)	Read	2words	Firmware Revision ex) 0x00010010 (Major revision 1 /Minor revision 16, Rev 1.016)
+ 0x19(+25)	Read	2words	Firmware release date.

* After the system is reset, the new "Set Value" action is applied.

** Nothing of output, input, memory or configuration parameter corresponding slot returns Exception 02.

3.5 MODBUS Reference

MODBUS Reference Documents

<http://www.modbus.org>

MODBUS Tools

<http://www.modbustools.com>, modbus poll

<http://www.win-tech.com>, modscan32

4. PARAMETER

4.1 GN-9287 Parameter

Parameter	Setting	Description
Word data type	All type	Little Endian format(LSB-MSB)
Stop action	Clear output image to 0 *	All outputs are set to 0.
	Hold last valid output image	All outputs are remain the last value.
Stop action_Mode	General Mode *	For SIEMENS PLC
	Special Mode	For Soft PLC(ex-CoDeSys)

* : Default setting

4.2 GN-9287 PROFINET IO Characteristics

4.2.1 Device Identity

Item	Value
Vendor	CREVIS
Vendor ID	0x0140
Product family	CREVIS FnIO System
Device ID	0x9A00
Details	GN9287 PROFINET IO Device

4.2.2 Device Access Point

Item	Value
Module Ident Number	0x00009A00
Details	GN9287 PROFINET IO Device
Vendor Name	CREVIS
Order Number	GN-9287
Category	CREVIS PROFINET I/O
Software Version	V1.0
Hardware Version	V1.0
Maximal Input Length	1440 Bytes
Maximal Output Length	1440 Bytes
Physical Slots	0..32
Minimal Device Interval	4msec
Based on	portStack
DNS Compliant Name	GN9287-xx
Supports Extended Assignment of IP Address	No
Fixed in Slots	0
Instance Field of the Object UUID	1
Supports Multiple Write	Yes
Requires IOPS/IOCS	Yes
Requires Engineering tool which supports at least GSDML Version	V2.32

4.2.3 Sub-slot of GN-9287

Item	Value
Sub-slot Number	Sub-slot Label
32768 (0x8000)	X1
32769 (0x8001)	P1

Sub-module								
Sub-module Ident Number	0x00000001							
GN-9287 Parameters (Index : 1, Length : 2Bytes, Transfer sequence : 0)								
Byte Offset	Data							
0	0x00, 0x00							
Name of	Data	Byte	Bit Offset	Bit	Default	Value	Changeable	Visible

Parameter	Type	Offset		Length	value	Range		
Word data format	Bit Area	0	0	1	MOTOROLA	0..1	Yes	Yes
Stop action	Bit Area	1	0	1	Clear output images to 0	0..1	Yes	Yes
Interface : GN-9287								
Sub-module Ident Number					0x0002			
Sub-slot Number					32768 (0x8000)			
Supports Real time Class					Class 1			
Supports Isochronous Mode					No			
Number of Additional Input CRs					0			
Number of Additional Output CRs					0			
Number of Additional Multicast Provider CRs					0			
Number of Multicast Consumer CRs					0			
Supported Send-clock Factors (Base 31.25us)					32 64 128			
Supported Reduction Ratios					1 2 4 8 16 32 64 128 256 512			
Port 1 : Port 1								
Sub-module Ident Number					0x0003			
Sub-slot Number					32769 (0x8001)			
MAU Type					100BASETXFD			