

# **FnIO G - Series:**

## ***GN-9284***

***GN-9284 (CC-Link IE Field Basic Network Adapter)***

## Table of Contents

Table of Contents.....	2
History.....	4
1.ENVIRONMENT SPECIFICATION.....	5
2.GN-9284 (CC-Link IE Field Basic Network Adapter).....	6
2.1.GN-9284 Specification.....	6
2.2.GN-9284 Wiring Diagram.....	8
2.3.GN-9284 LED Indicator.....	9
2.3.1.LED Indicator.....	9
2.3.2.MOD (Module Status LED).....	9
2.3.3.DLINK (Cyclic transmission status LED).....	9
2.3.4.RUN/ERR (Operating/Error occurrence status LED).....	9
2.3.5.IOS LED (Extension Module Status LED).....	10
2.3.6.Field Power, System Power LED (Field Power, System Power Status LED).....	10
2.4.GN-9284 Electrical Interface.....	11
2.4.1.RJ-45 Socket.....	11
2.4.2.Dip Switch (TBD).....	11
2.4.3.RS232 Port for MODBUS/RTU, Touch Pannel or IOGuide.....	11
2.4.4.Output HOLD/CLEAR setting Function.....	12
2.5.MODBUS/TCP IP – Address Setup.....	13
2.5.1.IP-Address Setup using BOOTP/DHCP Sever.....	13
2.5.2.IP-Address Setup using Dip Switch(Manual Function).....	14
2.6.MODBUS/TCP IP – Web Server.....	15
2.7.I/O Process Image Map.....	17
2.7.1.MODBUS Interface Register/Bit Map.....	17
2.7.2.Example of Input Process Image (Input Register) Map.....	18
2.7.3.Example of Output Process Image (Output Register) Map.....	19
3.MODBUS TCP/ UDP INTERFACE.....	20
3.1.MODBUS TCP/ UDP Protocol.....	20
3.1.1.Comparison of MODBUS TCP/ UDP And MODUB/RTU.....	20
3.1.2.MODBUS TCP/ UDP MBAP Header.....	20
3.2.Supported MODBUS Function Codes.....	21
3.2.1.1 (0x01) Read Coils.....	21
3.2.2.2 (0x02) Read Discrete Inputs.....	22
3.2.3.3 (0x03) Read Holding Resgisters.....	22
3.2.4.4 (0x04) Read Input Resgisters.....	23

---

<a href="#">3.2.5.5 (0x05) Write Single Coil.....</a>	<a href="#">23</a>
<a href="#">3.2.6.6 (0x06) Write Single Register.....</a>	<a href="#">24</a>
<a href="#">3.2.7.8 (0x08) Diagnostics.....</a>	<a href="#">24</a>
<a href="#">3.2.8.15 (0x0F) Write Multiple Coils.....</a>	<a href="#">26</a>
<a href="#">3.2.9.16 (0x10) Write Multiple Resgisters.....</a>	<a href="#">26</a>
<a href="#">3.2.10.23 (0x17) Read/Write Multiple Resgisters.....</a>	<a href="#">27</a>
<a href="#">3.2.11.Error Response.....</a>	<a href="#">28</a>
<a href="#">3.3.MODBUS Special Register Map.....</a>	<a href="#">29</a>
<a href="#">3.3.1.Adapter Identification Special Resgister (0x1000, 4096).....</a>	<a href="#">29</a>
<a href="#">3.3.2.Adapter Watchdog Time, other Time Special Register (0x1020, 4128).....</a>	<a href="#">29</a>
<a href="#">3.3.3.Adapter TCP/IP Special Register (0x1040, 4160).....</a>	<a href="#">30</a>
<a href="#">3.3.4.Adapter Information Special Register (0x1100, 4352).....</a>	<a href="#">30</a>
<a href="#">3.3.5.Expasion Slot Information Special Resister (0x2000, 8192).....</a>	<a href="#">32</a>
<a href="#">3.4.MODBUS Reference.....</a>	<a href="#">33</a>

## History

REV.	PAGES	REMARKS	DATE	Editor
Preliminary		Preliminary	Aug 17, 2017	GWLEE
1.01		Add register output_hold_clear	Jan 30, 2018	GWLEE
1.02		Example of Input Process Image (Input Register) Map	Aug 9, 2018	GWLEE
1.03		Node, speed spec. changed	Sep 11, 2018	GWLEE
1.04		Process Image Map	Nov 12, 2018	GWLEE
1.05		Special Register(0x1119)ModBus status, Internal bus status.	May 24, 2019	GWLEE
1.06		Using IAP Mode	Oct 10, 2019	GWLEE
1.07		Revision related to UL certification	Mar 10, 2020	GWLEE

## 1. ENVIRONMENT SPECIFICATION

<b>Environmental specification</b>	
Operating Temperature	60°C~70°C: Power dissipation is limited to 0.8A. -40°C~60°C: 1.5A full load is allowed.
UL Temperature	-20°C~60°C
Storage Temperature	-40°C~85°C
Relative Humidity	5%~90% non-condensing
Mounting	DIN rail
<b>General specification</b>	
Shock Operating	IEC 60068-2-27
Vibration Resistance	Based on IEC 60068-2-6 DNVGL-CG-0039 : Vibration Class B, 4g
Industrial Emissions	EN 61000-6-4/A11 : 2011
Industrial Immunity	EN 61000-6-2 : 2005
Installation Position	Vertical and horizontal installation is available.
Product Certifications	CE, UL, FCC

## 2. GN-9284 (CC-Link IE Field Basic Network Adapter)

### 2.1. GN-9284 Specification

Items	Specification
<b>Communication Specification</b>	
Adapter Type	Slave station (CC-Link IE Field Basic Server)
Protocol	CC-Link IE Field Basic, SLMP
Sub-Protocol	MODBUS/TCP,MODBUS/UDP,HTTP,DHCP,10 TCP Connections
Port number	61450 (CyclicData) 61451 (port number of the slave station of Node Search)
Max. Expantsion Module	32 slots
Number of occupied stations	1 ~ 4 stations
Max. Data Size(RX, RY)	each 32 bytes (4 Stations occupied)
Max. Data Size(RWr, RWw)	each 256 bytes (4 Stations occupied)
Max. link points per station (RX, RY)	each 64 points
Max. link points per station (RWr, RWw)	each 32 points
Max Length Bus Line	Up to 100m from Ethernet Hub/Switch with twisted CAT5 UTP/STP
Max. Nodes	64 node
Baud Rate	10/100Mbps, Auto-negotiation, Full duplex
Interface Connector	RJ-45 socket * 2pcs
IP-Address Setup	Via DHCP/BOOTP or IOGuide(Crevis Software)
IP-Address Range	xxx.xxx.xxx.1 ~ 253 (User area) xxx.xxx.xxx.254 ~ 255 (Reserved for IAP Function)
IAP Mode	When DIP Switch 1 to 8 setting is 254 or 255 (Using only Internet Explorer / recommended version 11 )
Serial Port	RS232 for MODBUS/RTU, Touch Pannel or IOGuide
Serial Configuration (RS232)	Node : 1 (Fixed) Baud Rate : 115200 (Fixed) Data bit : 8 (Fixed) Parity bit : No parity (Fixed) Stop bit : 1 (Fixed)
Indicator	6 LED 1 Green/Red, Module Status (MOD) 1 Green, Physical Connection (DLINK) 1 Green, Exchange Data/Traffic Present (RUN/ERR) 1 Green/Red, Expansion I/O Module Status (IOS) 1 Green, System Power Status 1 Green, Field Power Status 2 LED (each RJ45 Connector) 1 Yellow, Link/Active 1 Green, Not used
Module Location	Starter module left side of G-Series system
Field Power Detection	About 14Vdc
<b>General specification</b>	
UL System Power	Supply voltage : 24Vdc nominal, Class 2
System Power	Supply voltage : 24Vdc nominal Supply voltage range : 15~30Vdc Protection : Output current limit (Min. 1.5A) Reverse polarity protection
Power Dissipation	70mA typical @ 24Vdc

Current for I/O Module	1.5A @ 5Vdc* (When using in '60°C~ 70°C temperature environment, the power dissipation is limited to 0.8A.)
Isolation	System power to internal logic : Non-isolation System power I/O driver : Isolation
UL Field Power	Supply voltage : 24Vdc nominal, Class 2
Field Power	Supply voltage : 24Vdc typical (Max. 30Vdc) Field Power Range is different depending on IO Module series. Refer to IO Module's Specification.
Max. Current Field Power Contact	DC 10A Max
Wiring	I/O Cable Max. 2.0mm <sup>2</sup> (AWG 14)
Torque	0.8Nm(7 lb-in)
Weight	162g
Module Size	54mm x 99mm x 70mm
<b>Environment Condition</b>	<b>Refer to '1. Environment Specification'</b>

\* When using in '60°C~ 70°C temperature environment, the power dissipation is limited to 0.8A.

## 2.2. GN-9284 Wiring Diagram

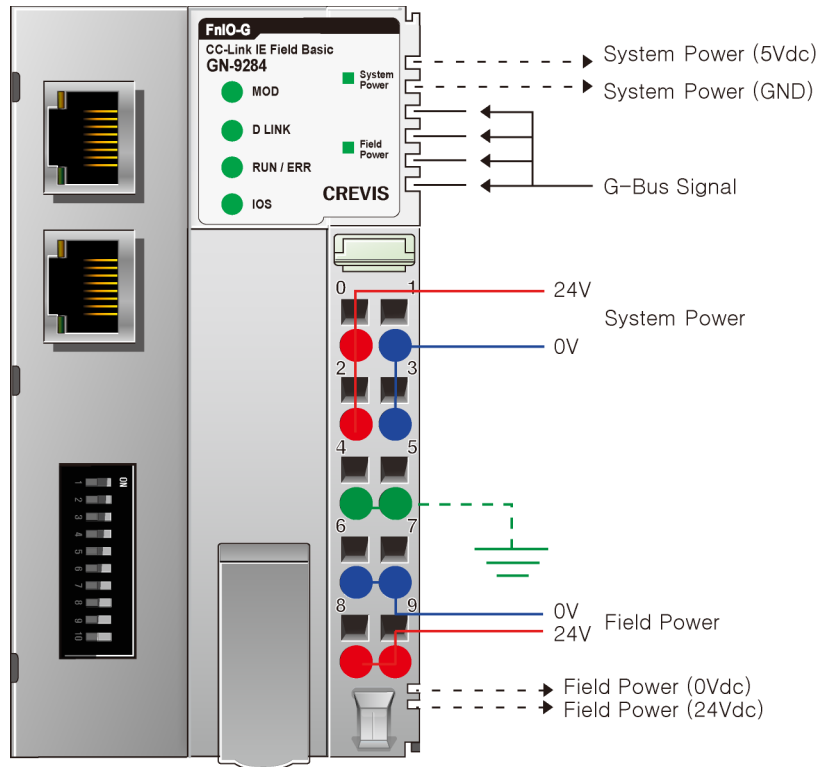

Pin No.	Signal Description	Signal Description	Pin No.
0	System Power, 24V	System Power, Ground	1
2	System Power, 24V	System Power, Ground	3
4	F.G	F.G	5
6	Field Power, Ground	Field Power, Ground	7
8	Field Power, 24V	Field Power, 24V	9



## 2.3. GN-9284 LED Indicator

### 2.3.1. LED Indicator

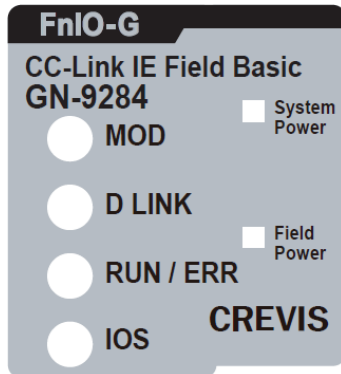

LED No.	LED Function / Description	LED Color
MOD	Module Status	Green/Red
DLINK	Physical Connection	Green
RUN/ERR	Exchange Data/Traffic Present	Green/Red
IOS	Extension Module Status	Green/Red
System Power	System Power Enable	Green
Field Power	Field Power Enable	Green

### 2.3.2. MOD (Module Status LED)

Status	LED	To indicate
Not Powered	OFF	Not power is supplied to the unit.
Device Operational	Green	The unit is operating in normal condition.
Device in Standby	Flashing Green	The device needs commissioning due to configuration missing, incomplete or incorrect.
MODBUS Error	Green/Red Toggle	MODBUS error such as watchdog error, etc.
Minor Fault	Flashing Red	Recoverable Fault. - EEPROM checksum fault.
Unrecoverable Fault	Red	The device has an unrecoverable fault. - Memory error or CPU watchdog error.

### 2.3.3. DLINK (Cyclic transmission status LED)

Status	LED	To indicate
Disconnected	OFF	Disconnected
Stop	Flashing Green	Cyclic transmission not being performed
Run	Green	Cyclic transmission being performed

### 2.3.4. RUN/ERR (Operating/Error occurrence status LED)

Status	LED	To indicate
Not Powered	OFF	Device is idle or may not be powered.
Normal operation	Green	The unit is operating in normal condition.
Minor Error	Flashing Red	Duplication of slave stations
Major Error	Red	Duplication of master stations Invalid the occupied stations

**2.3.5. IOS LED (Extension Module Status LED)**

Status	LED	To indicate
Not Powered	OFF	Device may not be powered.
No Expansion Module	Flashing Red	Adapter has no expansion module
Internal Bus Connection, Run Exchanging I/O	Green	Exchanging I/O data.
Expansion Configuration Failed	Red	One or more expansion module occurred in fault state. <ul style="list-style-type: none"> <li>- Detected invalid expansion module ID.</li> <li>- Overflowed Input/Output Size</li> <li>- Too many expansion module</li> <li>- Initialization failure</li> <li>- Communication failure.</li> <li>- Changed expansion module configuration.</li> <li>- Mismatch vendor code between adapter and expansion module.</li> </ul>

**2.3.6. Field Power, System Power LED (Field Power, System Power Status LED)**

Status	LED	To indicate
No field, System power	OFF	Not supplied 24Vdc field power, 5Vdc system power.
Supplied field, System power	Green	Supplied 24Vdc field power, 5Vdc system power.

## 2.4. GN-9284 Electrical Interface

### 2.4.1. RJ-45 Socket

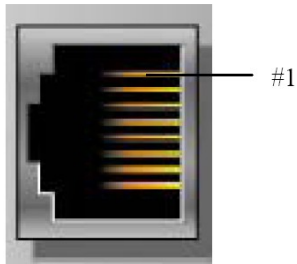

Shielded RJ-45 Socket

RJ-45	Signal Name	Description
1	TD+	Transmit +
2	TD-	Transmit -
3	RD+	Receive +
4	-	
5	-	
6	RD-	Receive -
7	-	
8	-	
Case	Shield	

### 2.4.2. Dip Switch (TBD)

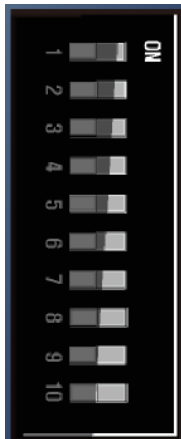

DIP Pole#	Description
1	IP_DIP bit#0
2	IP_DIP bit#1
3	IP_DIP bit#2
4	IP_DIP bit#3
5	IP_DIP bit#4
6	IP_DIP bit#5
7	IP_DIP bit#6
8	IP_DIP bit#7
9	= ON : Enable DHCP/BOOTP *
10	= ON : Use Lowest IP Address with IP_DIP value

Lowest IP Address when Pole#10=ON  
 ex) XXX.XXX.XXX.IP\_DIP

\* DHCP/BOOTP have to be set in special register(default : BOOTP).  
 (0x1045, ref 3.3.3).`

### 2.4.3. RS232 Port for MODBUS/RTU, Touch Panel or IOGuide

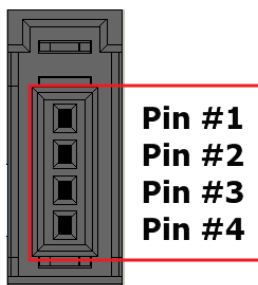

RS232 (37204-62A3-004PL/3M)		
Pin#	Signal Name	Description
1	Reserved	----
2	TXD	RS232 TXD
3	RXD	RS232 RXD
4	GND	RS232 GND

**2.4.4. Output HOLD/CLEAR setting Function**

When HOLD or CLEAR is set for an output, the output is turned on or off as follows.(0x111F, ref 3.3.4)

Operation status		HOLD		CLEAR	
		Last output status ON	Last output status OFF	Last output status ON	Last output status OFF
Data link in operation	Master in RUN	ON	OFF	ON	OFF
	Master in STOP	ON	OFF	OFF	OFF
	Master in PAUSE	ON	OFF	ON	OFF
	Master in RESET	ON	OFF	OFF	OFF
	Master suspended by error	ON	OFF	OFF	OFF
During disconnection/cyclic stop		ON	OFF	OFF	OFF

## 2.5. MODBUS/TCP IP – Address Setup

### 2.5.1. IP-Address Setup using BOOTP/DHCP Sever

If the adapter BOOTP/DHCP enabled (DIP Pole#9 ON), the adapter sends BOOTP/DHCP request message of 20 times every 2sec. If BOOTP/DHCP sever does not response, the Adapter applies its IP Address with EEPROM (Latest saved IP Address).

The following is an example of adapter IP-Address setup that can be used with a third party BOOTP/DHCP server.

- CREVIS IO Guide Pro' s BOOTP server

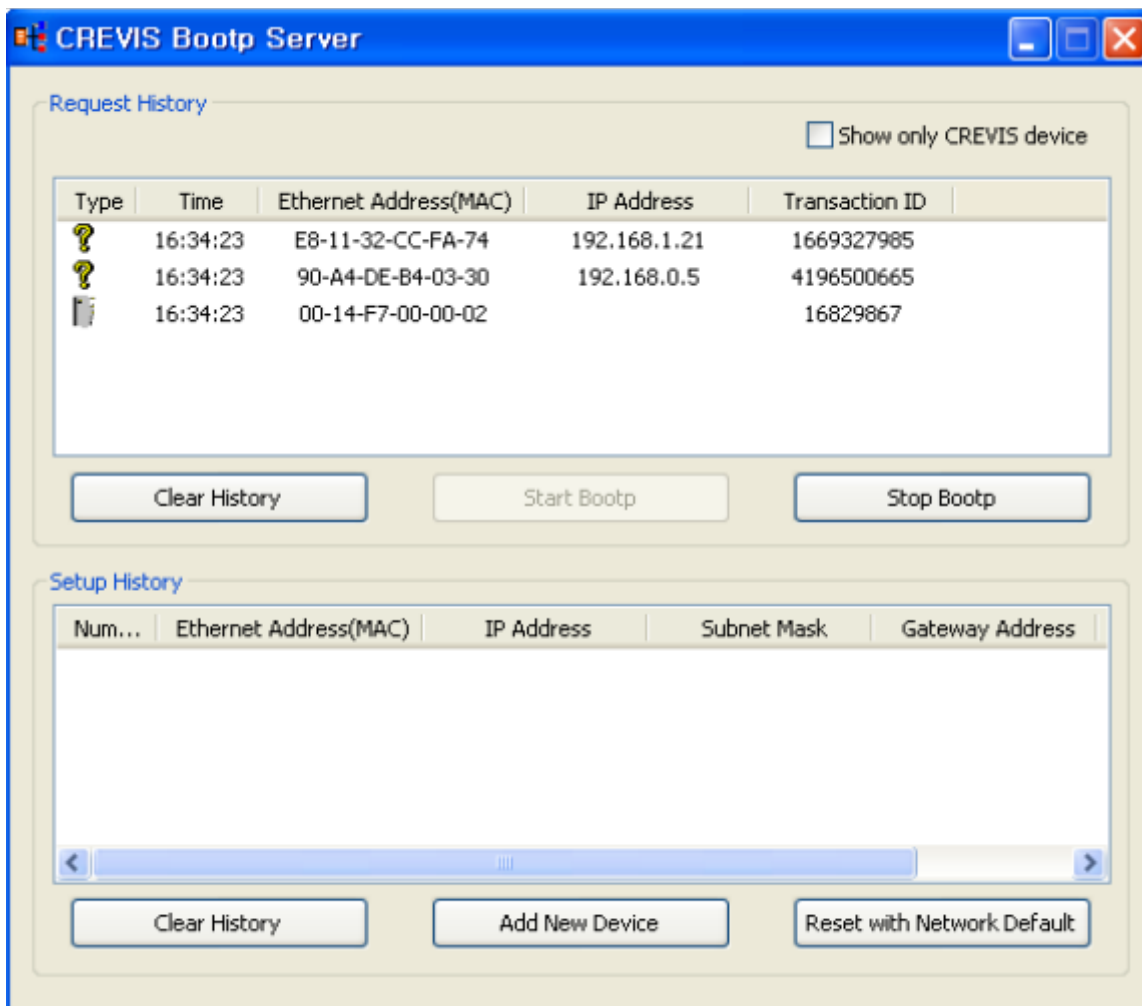

## 2.5.2. IP-Address Setup using Dip Switch(Manual Function)

If the adapter DIP Pole#10 is ON, lowest IP address is set by DIP Pole#1~#8 manually. Refer to 2.4.2.

These are examples of adapter IP-Address setup by manual function.

Ex) xxx . xxx . xxx . 1



Ex) xxx . xxx . xxx . 2



Ex) xxx . xxx . xxx . 8



Ex) xxx . xxx . xxx . 253



## 2.6. MODBUS/TCP IP – Web Server

- Network Adapter



www.crevis.co.kr

Crevis FnIO The Creative present makes Vision of future

**Network Adapter**

**GN-9284(CC-Link IE Field Basic) Network Adapter**

Io Input Data / Io Output Data

- IP Address : 192.168.3.8
- Subnet Mask : 255.255.255.0
- Gateway : 192.168.0.1
- MAC Address : 00:14:F7:00:00:02
- DIP DHCP/BOOTP : Enabled
- DIP IP Address : Enabled

- TCP/UDP Connections : Available
- Ethernet/IP Connections : Available
- MODBUS/TCP Connections : Available
- MODBUS/UDP Connections : Available
- HTTP(Web Server) Connections : Available
- MODBUS/RTU(RS232) Communication : Available

- Firmware Revision : 1.000(07/03/2017)
- Expansion Modules : 2 module(s)
- IO Size(Input) : 2 byte(s)
- IO Size(Output) : 2 byte(s)

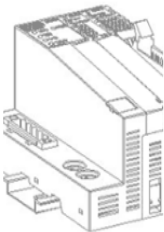



- Expansion Module



www.crevis.co.kr

**Crevis FnIO**

The Creative present makes Vision of future

Network Adapter

**GN-9284(CC-Link IE Field Basic) Network Adapter**

---

Io Input Data / Io Output Data

---

Slot#	Descriptions	Input Reg. Mapping	Output Reg. Mapping
<u>Slot#1</u>	GT-221F, 16DO, 24Vdc, Sink	_____	0x0800/0
<u>Slot#2</u>	GT-123F, 16DI, 24Vdc, Universal	0x0000/0	_____

---

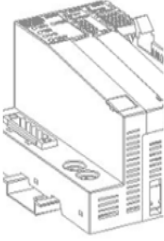



## 2.7. I/O Process Image Map

An expansion module may have 3 types of data as I/O data, configuration parameter and memory register. The data exchange between network adapter and expansion modules is done via an I/O process image data by G-Series protocol. The following figure shows the data flow of process image between network adapter and expansion modules.

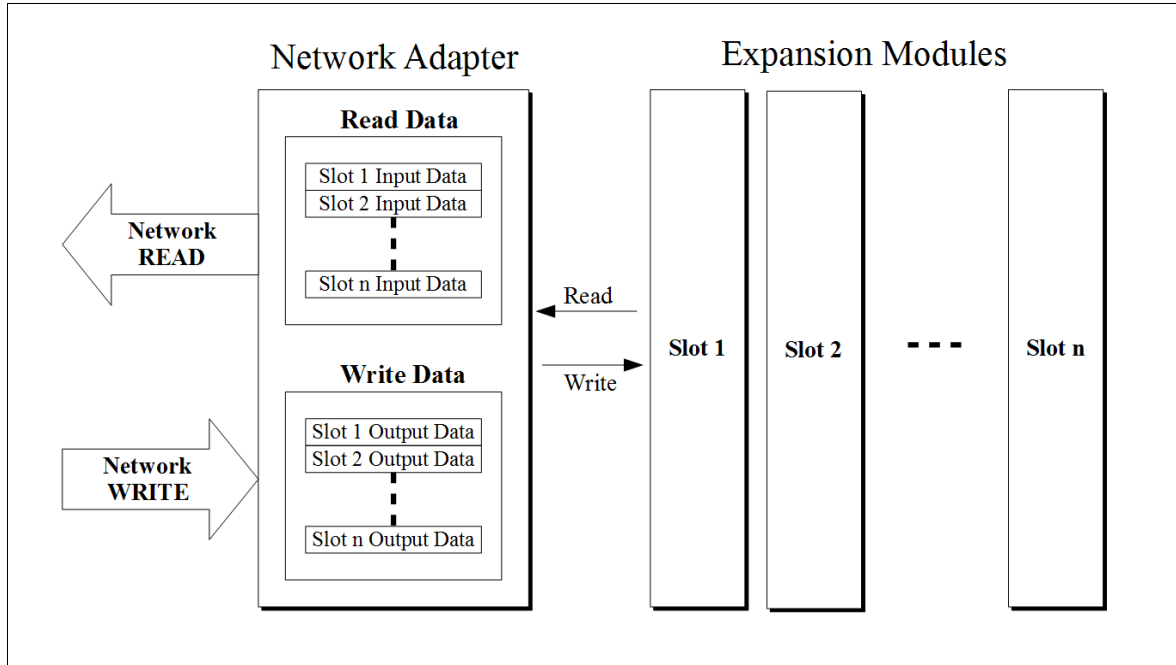

### 2.7.1. MODBUS Interface Register/Bit Map

- Register Map

Start Address	Read/Write	Description	Func. Code
0x0000 ~	Read	Process input image registers (Real Input Register)	3,4,23
0x0800 ~	Read/Write	Process output image registers (Real Output Register)	3,16,23
0x1000 *	Read	Adapter Identification special registers.	3,4,23
0x1020 *	Read/Write	Adapter Watchdog, other time special register.	3,4,6,16,23
0x1100 *	Read/Write	Adapter Information special registers.	3,4,6,16,23
0x2000 *	Read/Write	Expansion Slot Information special registers.	3,4,6,16,23

\* The special register map must be accessed by read/write of every each address (one address).

- Register Map

Start Address	Read/Write	Description	Func. Code
0x0000~	Read	Process input image bits All input registers area are addressable by bit address. Size of input image bit is size of input image register * 16.	2
0x1000~	Read/Write	Process output image bits All output registers area are addressable by bit address. Size of output image bit is size of output image register * 16.	1,5,15

## 2.7.2. Example of Input Process Image (Input Register) Map

Input image data depends on slot position and expansion slot data type. Input process image data is only ordered by expansion slot position

- For example slot configuration

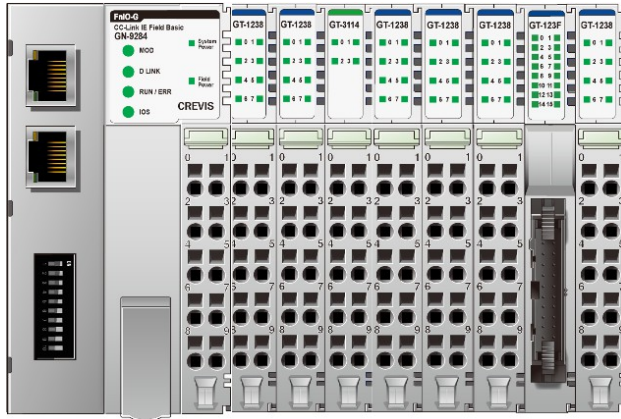

Slot No.	Module Description
#0	CC-Link IEFB Adapter
#1	8-discrete input
#2	8-discrete input
#3	4-analog input
#4	8-discrete input
#5	8-discrete input
#6	8-discrete input
#7	16-discrete input
#8	8-discrete input

- Input Process Image

Address	b15	b14	b13	b12	b11	b10	b9	b8	b7	b6	b5	b4	b3	b2	b1	b0
0x0000	Discrete Input 8 pts (Slot#2)								Discrete Input 8 pts (Slot#1)							
0x0001	Analog Input Ch0 high byte (Slot#3)								Analog Input Ch0 low byte (Slot#3)							
0x0002	Analog Input Ch1 high byte (Slot#3)								Analog Input Ch1 low byte (Slot#3)							
0x0003	Analog Input Ch2 high byte (Slot#3)								Analog Input Ch2 low byte (Slot#3)							
0x0004	Analog Input Ch3 high byte (Slot#3)								Analog Input Ch3 low byte (Slot#3)							
0x0005	Discrete Input 8 pts (Slot#5)								Discrete Input 8 pts (Slot#4)							
0x0006	Discrete Input 8 pts (Slot#7)								Discrete Input 8 pts (Slot#6)							
0x0007	Discrete Input 8 pts (Slot#8)								Discrete Input 8 pts (Slot#7)							

## 2.7.3. Example of Output Process Image (Output Register) Map

Output image data depends on slot position and expansion slot data type. Output process image data is only ordered by expansion slot position.

- For example slot configuration

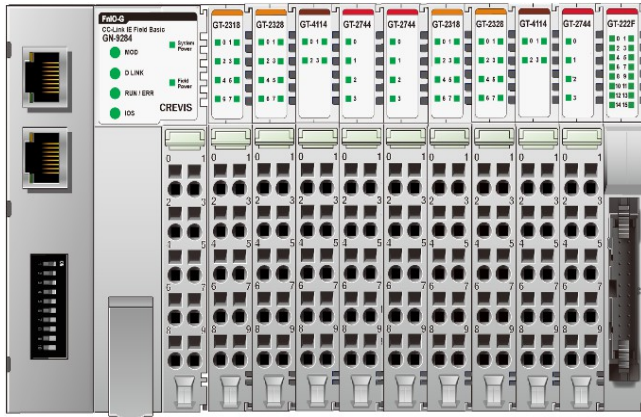

Slot No.	Module Description
#0	CC-Link IEFB Adapter
#1	8-discrete output
#2	8-discrete output
#3	4-analog output
#4	4- relay output
#5	4-relay output
#6	8-discrete output
#7	8-discrete output
#8	4-analog output
#9	4-relay output
#10	16-discrete output

- Output Process Image

Address	b15	b14	b13	b12	b11	b10	b9	b8	b7	b6	b5	b4	b3	b2	b1	b0
0x0800	Discrete Output 8 pts (Slot#2)								Discrete Output 8 pts (Slot#1)							
0x0801	Analog Output Ch0 high byte (Slot#3)								Analog Output Ch0 low byte (Slot#3)							
0x0802	Analog Output Ch1 high byte (Slot#3)								Analog Output Ch1 low byte (Slot#3)							
0x0803	Analog Output Ch2 high byte (Slot#3)								Analog Output Ch2 low byte (Slot#3)							
0x0804	Analog Output Ch3 high byte (Slot#3)								Analog Output Ch3 low byte (Slot#3)							
0x0805	Empty, Don't Care				Discrete Out 4 pts (Slot#5)				Empty, Don't Care				Discrete Out 4 pts (Slot#4)			
0x0806	Discrete Output low 8 pts (Slot#7)								Discrete Output low 8 pts (Slot#6)							
0x0807	Analog Output Ch0 high byte (Slot#8)								Analog Output Ch0 low byte (Slot#8)							
0x0808	Analog Output Ch1 high byte (Slot#8)								Analog Output Ch1 low byte (Slot#8)							
0x0809	Analog Output Ch2 high byte (Slot#8)								Analog Output Ch2 low byte (Slot#8)							
0x080A	Analog Output Ch3 high byte (Slot#8)								Analog Output Ch3 low byte (Slot#8)							
0x080B	Discrete Output low 8 pts (Slot#10)								Empty, Don't Care				Discrete Out 4 pts (Slot#9)			
0x080C	Empty, Don't Care								Discrete Output high 8 pts (Slot#10)							

### 3. MODBUS TCP/ UDP INTERFACE

#### 3.1. MODBUS TCP/ UDP Protocol

The MODBUS messaging service provides a Client/Server communication between devices connected on an Ethernet TCP/IP network. All MODBUS/TCP messages are sent via TCP on registered port 502. Refer to Modbus\_Messaging\_Implementation\_Guide\_V1\_0a.pdf.

##### 3.1.1. Comparison of MODBUS TCP/ UDP And MODBUS/RTU

This header provides some differences compared to the MODBUS RTU application data unit used on serial line:

- The MODBUS ‘slave address’ field usually used on MODBUS Serial Line is replaced by a single byte ‘Unit Identifier’ within the MBAP Header. The ‘Unit Identifier’ is used to communicate via devices such as bridges, routers and gateways that use a single IP address to support multiple independent MODBUS end units.
- All MODBUS requests and responses are designed in such a way that the recipient can verify that a message is finished. For function codes where the MODBUS PDU has a fixed length, the function code alone is sufficient. For function codes carrying a variable amount of data in the request or response, the data field includes a byte count.
- When MODBUS is carried over TCP, additional length information is carried in the MBAP header to allow the recipient to recognize message boundaries even if the message has been split into multiple packets for transmission. The existence of explicit and implicit length rules, and use of a CRC-32 error check code (on Ethernet) results in an infinitesimal chance of undetected corruption to a request or response message.

##### MODBUS TCP/ UDP

MBAP Header	Function	Data
7 chars	1 char	Up to 252 chars

##### MODBUS/ RTU

Start	Address	Function	Data	CRC Check	End
≥ 3.5 char	1 char	1 char	Up to 252 chars	2 chars	≥ 3.5 char

Function and data field of MODBUS/TCP are identical to function and data field of MODBUS/RTU.

##### 3.1.2. MODBUS TCP/ UDP MBAP Header

The MBAP (MODBUS Application Protocol) header contains the following fields.

Fields	Length	Description	Client	Server
Transaction Identifier	2bytes	Identification of a MODBUS Request /Response transaction.	Initialized by the client	Recopied by the server from the received
Protocol Identifier	2bytes	0 = MODBUS protocol	Initialized by the client	Recopied by the server from the received
Length	2bytes	Number of following bytes	Initialized by the client (Request)	Initialized by the server (Response)
Unit Identifier	1byte	Identification of a remote slave connected on a serial line or on other buses.	Initialized by the client	Recopied by the server from the received

- Transaction Identifier - It is used for transaction pairing, the MODBUS server copies in the response the transaction identifier of the request.
- Protocol Identifier – It is used for intra-system multiplexing. The MODBUS protocol is identified by the value 0.
- Length - The length field is a byte count of the following fields, including the Unit Identifier and data fields.
- Unit Identifier – This field is used for intra-system routing purpose. Typically MODBUS server must be returned with the same value set by MODBUS client.

### 3.2. Supported MODBUS Function Codes

Function Code	Function	Description
1(0x01)	Read Coils	Read output bit
2(0x02)	Read Discrete Inputs	Read input bit
3(0x03)	Read Holding Registers	Read output word
4(0x04)	Read Input Registers	Read input word
5(0x05)	Write Single Coil	Write one bit output
6(0x06)	Write Single Register	Write one word output
8(0x08)	Diagnostics	Read diagnostic register
15(0x0F)	Write Multiple Coils	Write a number of output bits
16(0x10)	Write Multiple registers	Write a number of output words
23(0x17)	Read/Write Multiple registers	Read a number of input words /Write a number of output words

- Refer to MODBUS APPLICATION PROTOCOL SPECIFICATION V1.1a

#### 3.2.1. 1 (0x01) Read Coils

This function code is used to read from 1 to 2000 contiguous status of coils in a remote device. The Request PDU specifies the starting address, i.e. the address of the first coil specified, and the number of coils. In the PDU Coils are addressed starting at zero. Therefore coils numbered 1-16 are addressed as 0-15. The coils in the response message are packed as one coil per bit of the data field. Status is indicated as 1= ON and 0= OFF.

- **Request**

Field name	Example
Function Code	0x01
Starting Address Hi	0x10
Starting Address Lo	0x00
Quantity of Outputs Hi	0x00
Quantity of Outputs Lo	0x0A

- **Response**

Field name	Example
Function Code	0x01
Byte Count	0x02
Output Status	0x55
Output Status	0x02

- In case of address 0x1015~0x1000 output bit value: 10101010\_01010101.

### 3.2.2. 2 (0x02) Read Discrete Inputs

This function code is used to read from 1 to 2000 contiguous status of discrete inputs in a remote device. The Request PDU specifies the starting address, i.e. the address of the first input specified, and the number of inputs. In the PDU Discrete Inputs are addressed starting at zero. Therefore Discrete inputs numbered 1-16 are addressed as 0-15. The discrete inputs in the response message are packed as one input per bit of the data field. Status is indicated as 1= ON; 0= OFF.

- **Request**

Field name	Example
Function Code	0x02
Starting Address Hi	0x00
Starting Address Lo	0x00
Quantity of Inputs Hi	0x00
Quantity of Inputs Lo	0x0A

- **Response**

Field name	Example
Function Code	0x02
Byte Count	0x02
Input Status	0x80
Input Status	0x00

- In case of address 0x0015~0x0000 input bit value: 00000000\_10000000.

### 3.2.3. 3 (0x03) Read Holding Registers

This function code is used to read the contents of a contiguous block of holding registers in a remote device. The Request PDU specifies the starting register address and the number of registers.

The register data in the response message are packed as two bytes per register, with the binary contents right justified within each byte. For each register, the first byte contains the high order bits and the second contains the low order bits.

- **Request**

Field name	Example
Function Code	0x03
Starting Address Hi	0x08
Starting Address Lo	0x00
Quantity of Register Hi	0x00
Quantity of Register Lo	0x02

- **Response**

Field name	Example
Function Code	0x03
Byte Count	0x04
Output Register#0 Hi	0x11
Output Register#0 Lo	0x22
Output Register#1 Hi	0x33
Output Register#1 Lo	0x44

- In case of address 0x0800, 0x0801 output register value: 0x1122, 0x3344.

### 3.2.4. 4 (0x04) Read Input Registers

This function code is used to read from 1 to approx. 125 contiguous input registers in a remote device. The Request PDU specifies the starting register address and the number of registers. The register data in the response message are packed as two bytes per register, with the binary contents right justified within each byte. For each register, the first byte contains the high order bits and the second contains the low order bits.

- **Request**

Field name	Example
Function Code	0x04
Starting Address Hi	0x00
Starting Address Lo	0x00
Quantity of Register Hi	0x00
Quantity of Register Lo	0x02

- **Response**

Field name	Example
Function Code	0x03
Byte Count	0x04
Input Register#0 Hi	0x00
Input Register#0 Lo	0x80
Input Register#1 Hi	0x00
Input Register#1 Lo	0x00

- In case of address 0x0000, 0x0001 input register value: 0x0080, 0x0000.

### 3.2.5. 5 (0x05) Write Single Coil

This function code is used to write a single output to either ON or OFF in a remote device. The requested ON/OFF state is specified by a constant in the request data field. A value of FF 00 hex requests the output to be ON. A value of 00 00 requests it to be OFF. All other values are illegal and will not affect the output.

- **Request**

Field name	Example
Function Code	0x05
Output Address Hi	0x10
Output Address Lo	0x01
Output Value Hi	0xFF
Output Value Lo	0x00

- **Response**

Field name	Example
Function Code	0x05
Output Address Hi	0x10
Output Address Lo	0x01
Output Value Hi	0xFF
Output Value Lo	0x00

- Output bit of address 0x1001 turns ON.

### 3.2.6. 6 (0x06) Write Single Register

This function code is used to write a single holding register in a remote device. Therefore register numbered 1 is addressed as 0. The normal response is an echo of the request, returned after the register contents have been written.

• **Request**

Field name	Example
Function Code	0x06
Register Address Hi	0x08
Register Address Lo	0x00
Register Value Hi	0x11
Register Value Lo	0x22

• **Response**

Field name	Example
Function Code	0x06
Register Address Hi	0x08
Register Address Lo	0x00
Register Value Hi	0x11
Register Value Lo	0x22

- In case of address 0x0800 output register value: 0x0000 changes to 0x1122.

### 3.2.7. 8 (0x08) Diagnostics

MODBUS function code 08 provides a series of tests for checking the communication system between a client (Master) device and a server (Slave), or for checking various internal error conditions within a server.

The function uses a two-byte sub-function code field in the query to define the type of test to be performed. The server echoes both the function code and sub-function code in a normal response. Some of the diagnostics cause data to be returned from the remote device in the data field of a normal response.

• **Request**

Field name	Example
Function Code	0x08
Sub-Function Hi	0x00
Sub-Function Lo	0x00
Data Hi	0x11
Data Lo	0x22

• **Response**

Field name	Example
Function Code	0x08
Sub-Function Hi	0x00
Sub-Function Lo	0x00
Data Hi	0x11
Data Lo	0x22



## Sub-function 0x0000(0) Return Query Data

The data passed in the request data field is to be returned (looped back) in the response.  
 The entire response message should be identical to the request.

Sub-function	Data Field (Request)	Data Field (Response)	Description
0x0000(0)	Any	Echo Request Data	

## Sub-function 0x0001(1) Restart Communications Option

The remote device could be initialized and restarted, and all of its communications event counters are cleared.  
 Especially, data field 0x55AA make the remote device to restart with factory default setup of EEPROM.

Sub-function	Data Field (Request)	Data Field (Response)	Description
0x0001(1)	0x0000 or 0xFF00	Echo Request Data	Reset
0x0001(1)	0x55AA+0xAB7B+Sumcheck	Echo Request Data	Reset with Factory default <sup>1)</sup>
0x0001(1)	0x55AA+0xAA55+Sumcheck	Echo Request Data	Reset with Factory default <sup>2)</sup>

1),2) IP Address, Subnet Mask Address, Gateway Address will be the factory defaults value.

2) Mac Address will be the factory default value.

## Sub-function 0x000A(10) Clear Counters and Diagnostic Register

The goal is to clear all counters and the diagnostic register. Counters are also cleared upon power-up.

Sub-function	Data Field (Request)	Data Field (Response)	Description
0x000A(10)	0x0000	Echo Request Data	

## Sub-function 0x000B(11) Return Bus Message Count

The response data field returns the quantity of messages that the remote device has detected on the communications system since its last restart, clear counters operation, or power-up.

Sub-function	Data Field (Request)	Data Field (Response)	Description
0x000B(11)	0x0000	Total Message Count	

## Sub-function 0x000C(12) Return Bus Communication Error Count

The response data field returns the quantity of CRC errors encountered by the remote device since its last restart, clear counters operation, or power-up.

Sub-function	Data Field (Request)	Data Field (Response)	Description
0x000C(12)	0x0000	CRC Error Count	

## Sub-function 0x000D(13) Return Bus Exception Error Count

The response data field returns the quantity of MODBUS exception responses returned by the remote device since its last restart, clear counters operation, or power-up.

Exception responses are described and listed in section 3.2.11.

Sub-function	Data Field (Request)	Data Field (Response)	Description
0x000D(13)	0x0000	Exception Error Count	

## Sub-function 0x000E(14) Return Slave Message Count

The response data field returns the quantity of messages addressed to the remote device, or broadcast, that the remote device has processed since its last restart, clear counters operation, or power-up.

Sub-function	Data Field (Request)	Data Field (Response)	Description
0x000E(14)	0x0000	Slave Message Count	

## Sub-function 0x000F(15) Return Slave No Response Count

The response data field returns the quantity of messages addressed to the remote device for which it has returned no response (neither a normal response nor an exception response), since its last restart, clear counters operation, or power-up.

Sub-function	Data Field (Request)	Data Field (Response)	Description
0x000F(15)	0x0000	Slave No Response Count	

## Sub-function 0x0064(100) Return Slave ModBus, Internal Bus Status

The response data field returns the status of ModBus and Internal Bus addressed to the remote device.

This status values are identical with status 1 word of input process image.

Sub-function	Data Field (Request)	Data Field (Response)	Description
0x0064(100)	0x0000	ModBus, Internal Bus Status	Same as status 1 word

### Sub-function 0x0065(101) Return Slave Watchdog Error Count

The response data field returns the quantity of watchdog error addressed to the remote device since its last restart, clear counters operation, or power-up.

Sub-function	Data Field (Request)	Data Field (Response)	Description
0x0065(101)	0x0000	Watchdog Error Count	

### 3.2.8. 15 (0x0F) Write Multiple Coils

This function code is used to force each coil in a sequence of coils to either ON or OFF in a remote device. The Request PDU specifies the coil references to be forced. Coils are addressed starting at zero. A logical '1' in a bit position of the field requests the corresponding output to be ON. A logical '0' requests it to be OFF.

The normal response returns the function code, starting address, and quantity of coils forced.

- Request**

Field name	Example
Function Code	0x0F
Starting Address Hi	0x10
Starting Address Lo	0x00
Quantity of Outputs Hi	0x00
Quantity of Outputs Lo	0x0A
Byte Count	0x02
Output Value#0	0x55
Output Value#1	0x01

- Response**

Field name	Example
Function Code	0x0F
Starting Address Hi	0x10
Starting Address Lo	0x00
Quantity of Outputs Hi	0x00
Quantity of Outputs Lo	0x0A

- In case of address 0x1015~0x1000 output bit value: 00000000\_00000000 changes to 00000001\_01010101.

### 3.2.9. 16 (0x10) Write Multiple Registers

This function code is used to write a block of contiguous registers (1 to approx. 120 registers) in a remote device. The requested written values are specified in the request data field. Data is packed as two bytes per register.

The normal response returns the function code, starting address, and quantity of registers written.

- Request**

Field name	Example
Function Code	0x0F
Starting Address Hi	0x10
Starting Address Lo	0x08
Quantity of Registers Hi	0x00
Quantity of Registers Lo	0x02
Byte Count	0x04
Register Value#0 Hi	0x11
Register Value#0 Lo	0x22
Register Value#1 Hi	0x33
Register Value#1 Lo	0x44

- Response**

Field name	Example
Function Code	0x0F
Starting Address Hi	0x10
Starting Address Lo	0x08
Quantity of Registers Hi	0x00
Quantity of Registers Lo	0x02

- In case of address 0x0800, 0x0801 output register value: 0x0000, 0x0000 changes to 0x1122, 0x3344.

### 3.2.10. 23 (0x17) Read/Write Multiple Registers

This function code performs a combination of one read operation and one write operation in a single MODBUS transaction. The write operation is performed before the read. The request specifies the starting address and number of holding registers to be read as well as the starting address, number of holding registers, and the data to be written. The byte count specifies the number of bytes to follow in the write data field.

The normal response contains the data from the group of registers that were read. The byte count field specifies the quantity of bytes to follow in the read data field.

• **Request**

Field name	Example
Function Code	0x17
Read Starting Address Hi	0x08
Read Starting Address Lo	0x00
Quantity of Read Hi	0x00
Quantity of Read Lo	0x02
Write Starting Address Hi	0x08
Write Starting Address Lo	0x00
Quantity of Write Hi	0x00
Quantity of Write Lo	0x02
Byte Count	0x04
Write Reg. Value#0 Hi	0x11
Write Reg. Value#0 Lo	0x22
Write Reg. Value#1 Hi	0x33
Write Reg. Value#1 Lo	0x44

• **Response**

Field name	Example
Function Code	0x17
Byte Count	0x04
Read Reg. Value#0 Hi	0x11
Read Reg. Value#0 Lo	0x22
Read Reg. Value#1 Hi	0x33
Read Reg. Value#1 Lo	0x44

- In case of address 0x0800, 0x0801 output register value: 0x0000, 0x0000 changes to 0x1122, 0x3344.

### 3.2.11. Error Response

In an exception response, the server sets the MSB of the function code to 1. This makes the function code value in an exception response exactly 80 hexadecimal higher than the value would be for a normal response.

- **Exception Response Example**

Field name	Example
Function Code	0x81
Exception Code	0x02

- **Exception Codes**

Exception Code	Name	Description
01	Illegal Function	The function code received in the query is not an allowable action for the server (or slave).
02	Illegal Data Address	The data address received in the query is not an allowable address for the server (or slave).
03	Illegal Data Value	A value contained in the query data field is not an allowable value for server (or slave).
04	Slave Device Failure	An unrecoverable error occurred while the server (or slave) was attempting to perform the requested action.
05	Acknowledge	The server (or slave) has accepted the request and is processing it, but a long duration of time will be required to do so.
06	Slave Device Busy	Specialized use in conjunction with programming commands. The server (or slave) is engaged in processing a long-duration program command. The client (or master) should retransmit the message later when the server (or slave) is free.
08	Memory Parity Error	The server (or slave) attempted to read record file, but detected a parity error in the memory. The client (or master) can retry the request, but service may be required on the server (or slave) device.
0A	Gateway Path Unavailable	Specialized use in conjunction with gateways, indicates that the gateway was unable to allocate an internal communication path from the input port to the output port for processing the request.

- GN-9284 response exception code 01, 02, 03, 04 and 06.

## 3.3. MODBUS Special Register Map

The special register map can be accessed by function code 3, 4, 6 and 16. Also the special register map must be accessed by read/write of every each address (one address).

### 3.3.1. Adapter Identification Special Resgister (0x1000, 4096)

Address	Access	Type, Size	Description
0x1000(4096)	Read	1word	Vendor ID = 0x02E5(741), Crevis. Co., Ltd.
0x1001(4097)	Read	1word	Device type = 0x000C, Network Adapter
0x1002(4098)	Read	1word	Product Code = 0x90B0
0x1003(4099)	Read	1word	Firmware revision, if 0x0100, revision 1.00
0x1004(4100)	Read	2words	Product unique serial number
0x1005(4101)	Read	String upto 38bytes	Product name string (ASCII) "GN-9284,CC-Link IE Field Basic, GBUS"
0x1006(4102)	Read	1word	Sum check of EEPROM
0x1010(4112)	Read	2words	Firmware release date
0x1011(4113)	Read	2words	Product manufacturing inspection date
0x101E(4126)	Read	7words - 1word - 1word - 1word - 1word - 1word - 2words  15words - 2words - 2words - 2words - 3words - 1word - 1word - 1word - 1word - 2words	Composite Id of following address * RTU mode 0x1100(4352), Modbus RS232 Node. (Fixed 0x0001) 0x1000(4096), Vendor ID 0x1001(4097), Device type 0x1002(4098), Product code 0x1003(4099), Firmware revision 0x1004(4100), Product serial number  *TCP mode 0x1050(4176), IP address 0x1051(4177), Subnet mask 0x1052(4178), Gateway 0x1053(4179), Ethernet physical address (MAC ID) 0x1000(4096), Vendor ID 0x1001(4097), Device type 0x1002(4098), Product code 0x1003(4099), Firmware revision 0x1004(4100), Product serial number

- String Type consists of valid string length (first 1word) and array of characters

### 3.3.2. Adapter Watchdog Time, other Time Special Register (0x1020, 4128)

A watchdog timer can be configured for timeout periods up to 65535(1unit=100msec). The Watchdog timer will timeout (timer decreased, reached 0) if ModBus operation to the slave node does not occur over the configured watchdog value, then the slave adapter forces that slot output value is automatically set to user-configured fault actions and values.

Address	Access	Type, Size	Description
0x1020(4128)	Read/Write	1word	Watchdog time value 16bit unsigned. The time value is represented by multiples of 100msec. The 0 (watchdog timeout disabled) is default value. A changing of watchdog time value resets watchdog error and counter.
0x1021(4129)	Read	1word	Watchdog timer remain value This value is decreased every 100msec
0x1022(4130)	Read	1word	Watchdog error counter, it is cleared by writing address 0x1020
0x1023(4131)	Read/Write	1word	Enable/disable auto recovery Watchdog error when receiving new frame. 0:Disable, 1:Enable(default). Its value is stored in EEPROM.
0x1028(4136)	Read	1word	IO update time, main loop time. (1usec unit)

### 3.3.3. Adapter TCP/IP Special Register (0x1040, 4160)

Address	Access	Type, Size	Description
0x1040(4160)	Read	1word	Reserved
0x1041(4161)	Read/Write	1word	MODBUS/TCP connection timeout time. (0.5sec unit) Maximum time of ModBus connection to stay to be opened without receiving a ModBus request. 0~3600 The 120 (60sec) is default value. The value 0 disables connection time out specially.  *Notice : When using Ethernet/IP only, this value should be '0' (disable).
0x1042(4162)	Read	1word	Number of ModBus/TCP connected
0x1043(4163)	Read	1word	ModBus/TCP port, fixed 502
0x1044(4164)	Read	1word	Ethernet Interface Speed, 10(10Mbps) or 100(100Mbps)
0x1045(4165)*	Read/Write	1word	IP Setting Method. 0: BOOTP, 1:DHCP
0x1046(4166)	---	---	Reserved.
0x1047(4167)	Read	1word	Status of DIP SW#9 DHCP/BOOTP(Enable/Disable). 0 : OFF, 1 : ON
0x1048(4168)	Read	1word	Enable/disable Lowest IP address via DIP Switch, 1:Enabled
0x1050(4176)	Read/Write	2words	IP address. If 192.168.123.1, then 0xA8C0, 0x017B. After update this value, IP address, Subnet mask and Gateway are applied as new one.
0x1051(4177)	Read/Write	2words	Subnet mask. If 255.255.255.0, then 0xFFFF, 0x00FF.
0x1052(4178)	Read/Write	2words	Gateway. If 192.168.123.254, then 0xA8C0, 0xFE7B.
0x1053(4179)	Read	3words	Ethernet physical address (MAC-ID). If 11-22-33-44-55-66, then 0x2211, 0x4433, 0x6655.

\* Power off and then power on, this value is applied.

### 3.3.4. Adapter Information Special Register (0x1100, 4352)

Address	Access	Type, Size	Description																
0x1102(4354)	Read	1word	Start address of input image word register. =0x0000																
0x1103(4355)	Read	1word	Start address of output image word register. =0x0800																
0x1104(4356)	Read	1word	Size of input image word register.																
0x1105(4357)	Read	1word	Size of output image word register.																
0x1106(4358)	Read	1word	Start address of input image bit. = 0x0000																
0x1107(4359)	Read	1word	Start address of output image bit. =0x1000																
0x1108(4360)	Read	1word	Size of input image bit.																
0x1109(4361)	Read	1word	Size of output image bit.																
0x110A(4362)	Read	1word	Update time for cyclic data change (same as 0x1028)																
0x110D(4365)	Read	1word	Current Dip Switch State and Field Power Status (MSB) ex) DHCP/Booth enable, Dip SW(0x01), Field Power On = 0x8101																
0x110E(4366)	Read	upto 33words	Expansion slot's GT-number including GN First 1word is adapter's number, if GN-9284, then 0x9284																
0x1110(4368)	Read	1word	Number of expansion slot																
0x1113(4371)	Read	upto 33words	Expansion slot Module Id. First 1word is adapter's module id.																
0x1119(4377)	Read	1word	Hi byte is ModBus status, low byte is internal status. Zero value means 'no error'.																
			<table border="1"> <thead> <tr> <th>ModBus status</th> <th>Internal bus status(G-Bus)</th> </tr> </thead> <tbody> <tr> <td>0x00 : No Error</td> <td>0x00 : OPERATING</td> </tr> <tr> <td>0x01 : ERR_DIP_SWITCH</td> <td>0x02 : CONNECT_FAULT</td> </tr> <tr> <td>0x40 : ERR_CRC_LRC</td> <td>0x03 : CONFIG_FAULT</td> </tr> <tr> <td>0x80 : ERR_WATCHDOG</td> <td>0x04 : NO_EXPANSION</td> </tr> <tr> <td></td> <td>0x05 : INVALID_ATTR_VALUE</td> </tr> <tr> <td></td> <td>0x06 : TOO_MUCH_DATA</td> </tr> <tr> <td></td> <td>0x07 : VENDOR_ERROR</td> </tr> </tbody> </table>	ModBus status	Internal bus status(G-Bus)	0x00 : No Error	0x00 : OPERATING	0x01 : ERR_DIP_SWITCH	0x02 : CONNECT_FAULT	0x40 : ERR_CRC_LRC	0x03 : CONFIG_FAULT	0x80 : ERR_WATCHDOG	0x04 : NO_EXPANSION		0x05 : INVALID_ATTR_VALUE		0x06 : TOO_MUCH_DATA		0x07 : VENDOR_ERROR
ModBus status	Internal bus status(G-Bus)																		
0x00 : No Error	0x00 : OPERATING																		
0x01 : ERR_DIP_SWITCH	0x02 : CONNECT_FAULT																		
0x40 : ERR_CRC_LRC	0x03 : CONFIG_FAULT																		
0x80 : ERR_WATCHDOG	0x04 : NO_EXPANSION																		
	0x05 : INVALID_ATTR_VALUE																		
	0x06 : TOO_MUCH_DATA																		
	0x07 : VENDOR_ERROR																		

			<div style="border: 1px solid black; padding: 5px;">         0x08 : NOT_EXPECTED_SLOT          0x09 : CRC_ERROR          0x80 : NO_FIELD_POWER       </div>
0x111D(4381)	Read	1word	Adapter G-Series Revision.
0x111F(4382)	Read/Write	1word	*Output Hold(0x0001), Clear(0x0000) setting (CC-Link IEF Basic) (Refer to 2.4.3.). Default Clear setting .

\* After the system is reset, the new “Set Value” action is applied.

\*\* If the slot location is changed, set default value automatically (all expansion slot are live).

### 3.3.5. Expansion Slot Information Special Resister (0x2000, 8192)

Each expansion slot has 0x20(32) address offset and same information structure.

- |                                     |                                   |
|-------------------------------------|-----------------------------------|
| Slot#1 0x2000(8192)~0x201F(8223)    | Slot#2 0x2020(8224)~0x203F(8255)  |
| Slot#3 0x2040(8256)~0x205F(8287)    | Slot#4 0x2060(8288)~0x207F(8319)  |
| Slot#5 0x2080(8320)~0x209F(8351)    | Slot#6 0x20A0(8352)~0x20BF(8383)  |
| Slot#7 0x20C0(8384)~0x20DF(8415)    | Slot#8 0x20E0(8416)~0x20FF(8447)  |
| Slot#9 0x2100(8448)~0x211F(8479)    | Slot#10 0x2120(8480)~0x213F(8511) |
| Slot#11 0x2140(8512)~0x215F(8543)   | Slot#12 0x2160(8544)~0x217F(8575) |
| Slot#13 0x2180(8576)~0x219F(8607)   | Slot#14 0x21A0(8608)~0x21BF(8639) |
| Slot#15 0x21C0(8640)~0x21DF(8671)   | Slot#16 0x21E0(8672)~0x21FF(8703) |
| Slot#17 0x2200(8704)~0x221F(8735)   | Slot#18 0x2220(8736)~0x223F(8767) |
| Slot#19 0x2240(8768)~0x225F(8799)   | Slot#20 0x2260(8800)~0x227F(8831) |
| Slot#21 0x2280(8832)~0x229F(8863)   | Slot#22 0x22A0(8864)~0x22BF(8895) |
| Slot#23 0x22C0(8896)~0x22DF(8927)   | Slot#24 0x22E0(8928)~0x22FF(8959) |
| Slot#25 0x2300(8960)~0x231F(8991)   | Slot#26 0x2320(8992)~0x233F(9023) |
| Slot#27 0x2340(9024)~0x235F(9055)   | Slot#28 0x2360(9056)~0x237F(9087) |
| Slot#29 0x2380(9088)~0x239F(9119)   | Slot#30 0x23A0(9120)~0x23BF(9151) |
| Slot#31 0x23C0(9152)~0x23DF(9183)   | Slot#32 0x23E0(9184)~0x23FF(9215) |
| Slot#33 0x2400(9216)~0x241F(9247)   | Slot#34 0x2420(9248)~0x243F(9279) |
| .....                               |                                   |
| Slot#63 0x27C0(10176)~0x27DF(10207) |                                   |

Address Offset	Expansion Slot#1	Expansion Slot#2	Expansion Slot#3	Expansion Slot#4	.....	Expansion Slot#63
+ 0x00(+0)	0x2000(8192)	0x2020(8224)	0x2040(8256)	0x2060(8288)	.....	0x27C0(10176)
+ 0x01(+1)	0x2001(8193)	0x2021(8225)	0x2041(8257)	0x2061(8289)	.....	0x27C1(10177)
+ 0x02(+2)	0x2002(8194)	0x2022(8226)	0x2042(8258)	0x2062(8290)	.....	0x27C2(10178)
+ 0x03(+3)	0x2003(8195)	0x2023(8227)	0x2043(8259)	0x2063(8291)	.....	0x27C3(10179)
+ 0x04(+4)	0x2004(8196)	0x2024(8228)	0x2044(8260)	0x2064(8292)	.....	0x27C4(10180)
+ 0x05(+5)	0x2005(8197)	0x2025(8229)	0x2045(8261)	0x2065(8293)	.....	0x27C5(10181)
+ 0x06(+6)	0x2006(8198)	0x2026(8230)	0x2046(8262)	0x2066(8294)	.....	0x27C6(10182)
+ 0x07(+7)	0x2007(8199)	0x2027(8231)	0x2047(8263)	0x2067(8295)	.....	0x27C7(10183)
+ 0x08(+8)	0x2008(8200)	0x2028(8232)	0x2048(8264)	0x2068(8296)	.....	0x27C8(10184)
+ 0x09(+9)	0x2009(8201)	0x2029(8233)	0x2049(8265)	0x2069(8297)	.....	0x27C9(10185)
+ 0x0A(+10)	0x200A(8202)	0x202A(8234)	0x204A(8266)	0x206A(8298)	.....	0x27CA(10186)
+ 0x0B(+11)	0x200B(8203)	0x202B(8235)	0x204B(8267)	0x206B(8299)	.....	0x27CB(10187)
+ 0x0C(+12)	0x200C(8204)	0x202C(8236)	0x204C(8268)	0x206C(8300)	.....	0x27CC(10188)
+ 0x0D(+13)	0x200D(8205)	0x202D(8237)	0x204D(8269)	0x206D(8301)	.....	0x27CD(10189)
+ 0x0E(+14)	0x200E(8206)	0x202E(8238)	0x204E(8270)	0x206E(8302)	.....	0x27CE(10190)
+ 0x0F(+15)	0x200F(8207)	0x202F(8239)	0x204F(8271)	0x206F(8303)	.....	0x27CF(10191)
+ 0x10(+16)	0x2010(8208)	0x2030(8240)	0x2050(8272)	0x2070(8304)	.....	0x27D0(10192)
+ 0x11(+17)	0x2011(8209)	0x2031(8241)	0x2051(8273)	0x2071(8305)	.....	0x27D1(10193)
+ 0x12(+18)	0x2012(8210)	0x2032(8242)	0x2052(8274)	0x2072(8306)	.....	0x27D2(10194)
+ 0x13(+19)	0x2013(8211)	0x2033(8243)	0x2053(8275)	0x2073(8307)	.....	0x27D3(10195)
+ 0x14(+20)	0x2014(8212)	0x2034(8244)	0x2054(8276)	0x2074(8308)	.....	0x27D4(10196)
+ 0x15(+21)	0x2015(8213)	0x2035(8245)	0x2055(8277)	0x2075(8309)	.....	0x27D5(10197)
+ 0x16(+22)	0x2016(8214)	0x2036(8246)	0x2056(8278)	0x2076(8310)	.....	0x27D6(10198)
+ 0x17(+23)	0x2017(8215)	0x2037(8247)	0x2057(8279)	0x2077(8311)	.....	0x27D7(10199)
+ 0x18(+24)	0x2018(8216)	0x2038(8248)	0x2058(8280)	0x2078(8312)	.....	0x27D8(10200)
+ 0x19(+25)	0x2018(8217)	0x2038(8249)	0x2058(8281)	0x2078(8313)	.....	0x27D9(10201)
+ 0x1A(+26)	0x201A(8218)	0x203A(8250)	0x205A(8282)	0x207A(8314)	.....	0x27DA(10202)
+ 0x1B(+27)	0x201B(8219)	0x203B(8251)	0x205B(8283)	0x207B(8315)	.....	0x27DB(10203)
+ 0x1C(+28)	0x201C(8220)	0x203C(8252)	0x205C(8284)	0x207C(8316)	.....	0x27DC(10204)
+ 0x1D(+29)	0x201D(8221)	0x203D(8253)	0x205D(8285)	0x207D(8317)	.....	0x27DD(10205)
+ 0x1E(+30)	0x201E(8222)	0x203E(8254)	0x205E(8286)	0x207E(8318)	.....	0x27DE(10206)
+ 0x1F(+31)	0x201F(8223)	0x203F(8255)	0x205F(8287)	0x207F(8319)	.....	0x27DF(10207)



Address Offset	Access	Type, Size	Description
+ 0x02(+2) **	Read	1 word	Input start register address of input image word this slot.
+ 0x03(+3) **	Read	1 word	Input word's bit offset of input image word this slot.
+ 0x04(+4) **	Read	1 word	Output start register address of output image word this slot.
+ 0x05(+5) **	Read	1 word	Output word's bit offset of output image word this slot.
+ 0x06(+6) **	Read	1 word	Input bit start address of input image bit this slot.
+ 0x07(+7) **	Read	1 word	Output bit start address of output image bit this slot.
+ 0x08(+8) **	Read	1 word	Size of input bit this slot
+ 0x09(+9) **	Read	1 word	Size of output bit this slot
+ 0x0A(+10)**	Read	n words	Read input data this slot
+ 0x0B(+11)**	Read/Write	n words	Read/write output data this slot
+ 0x0E(+14)	Read	1 word	GT-number, if GT-1238, returns 0x1238
+ 0x0F(+15)	Read	String upto 72bytes	First 1word is length of valid character string. If GT-1238, returns "00 1E 52 54 2D 31 32 33 38 2C 20 38 44 49 2C 20 32 34 56 64 63 2C 20 55 6E 69 76 65 72 73 61 6C 00 00" Valid character size = 0x001E =30 characters, "GT-1238, 8DI, 24Vdc, Universal"
+ 0x10(+16)	Read	1 word	Size of configuration parameter byte
+ 0x11(+17)**	Read/Write	n words	Read/write Configuration parameter data, up to 8byte. Refer to A.2 ***
+ 0x17(+23)	Read	2words	Firmware Revision ex) 0x00010010 (Major revision 1 /Minor revision 16, Rev 1.016)
+ 0x19(+25)	Read	2words	Firmware release date.

\* After the system is reset, the new "Set Value" action is applied.

\*\* Nothing of output, input, memory or configuration parameter corresponding slot returns Exception 02.

## 3.4. MODBUS Reference

MODBUS Reference Documents

<http://www.modbus.org>

MODBUS Tools

<http://www.modbustools.com>, modbus poll

<http://www.win-tech.com>, modscan32