

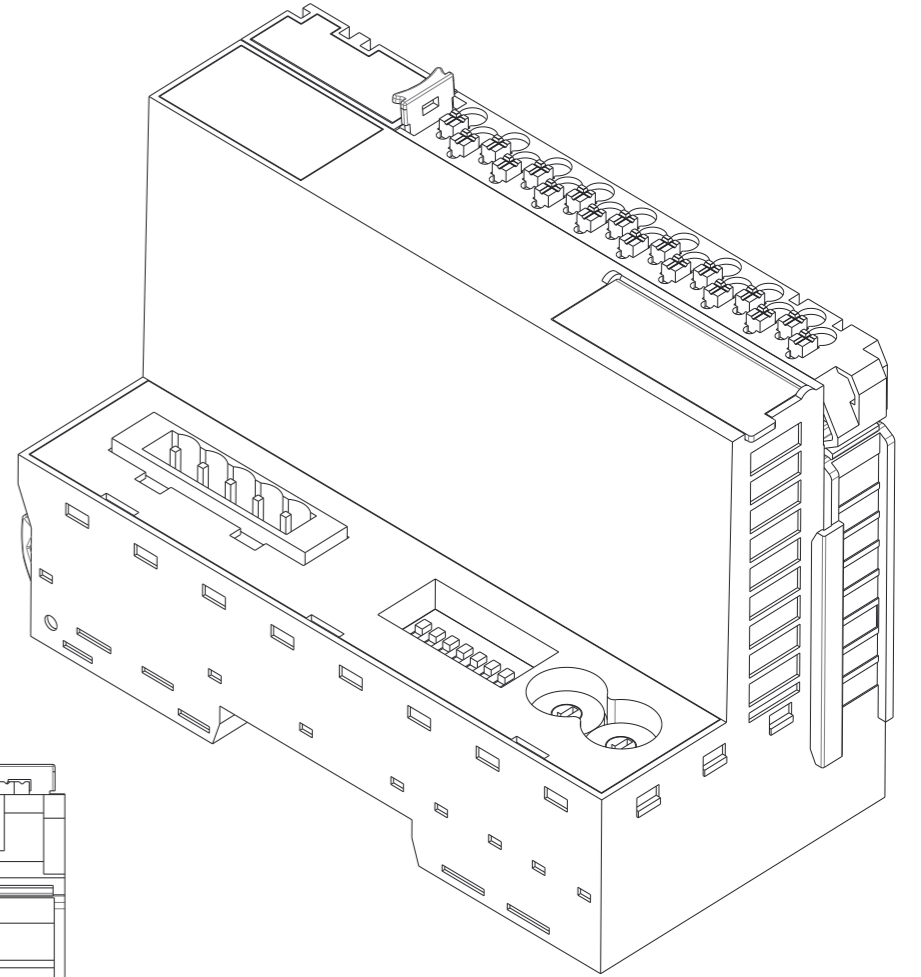

NO.	변경사항	변경사유	수정	심사	승인
1					
2					
3					

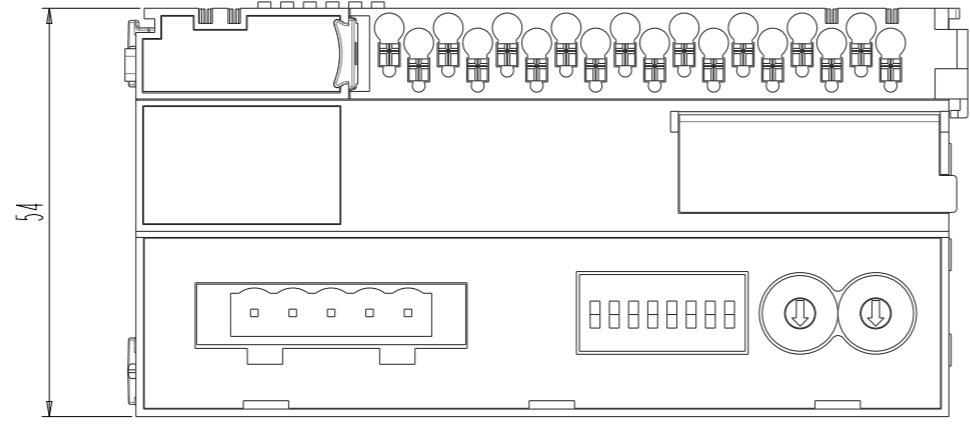

비율 1.000

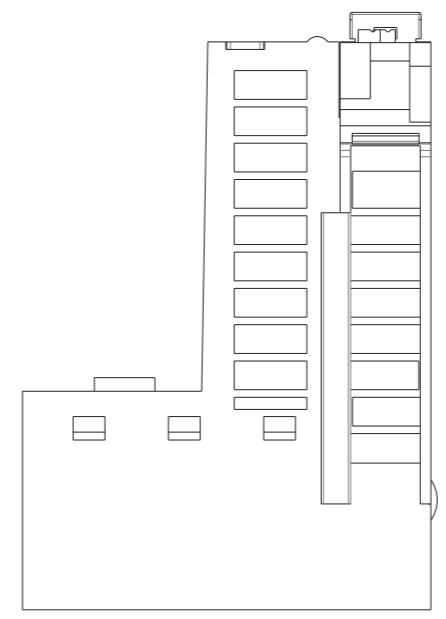
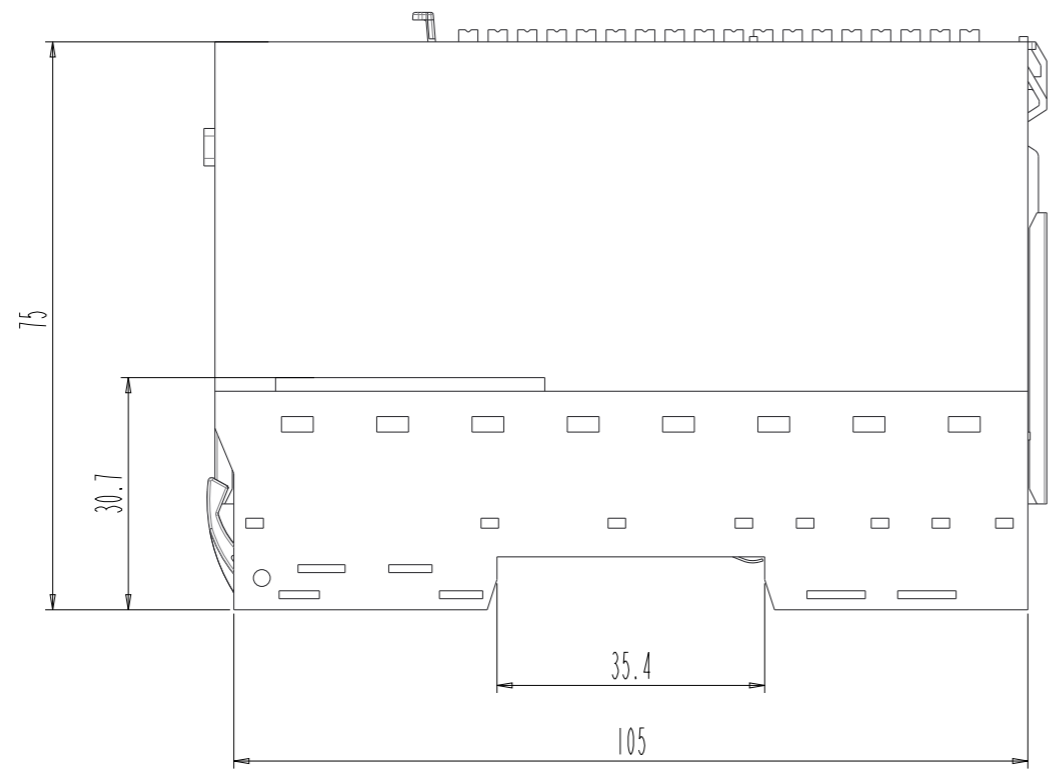
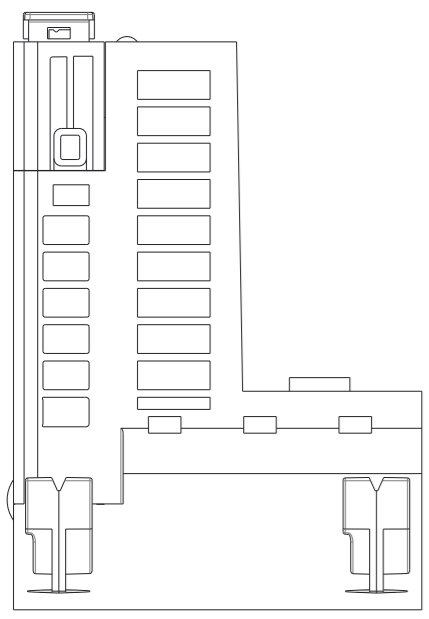

03	Fn10 M-Series MS Module_RTU ASS'Y(Rev1.00)					--	--	--
No'	PART NAME					Q'TY	MATERIAL	COLOR
Unit	M/M	Drawer	MG SEO	DWG No	M_NS_MODULE	TITLE		Fn10 M-Series
CVS Code		Designer	MG SEO	Scale	1:1			
Projection		Checker	MG YEO	Date	2021.04.08			

Dimension	Precision
0 < dim < 5	± 0.05
5 < dim < 30	± 0.1
30 < dim < 100	± 0.2
100 < dim < 300	± 0.4
300 < dim	± 0.8